

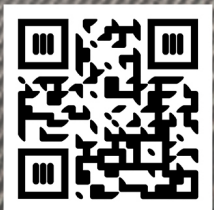

ARCHITECTURAL & INTERIOR APPLICATIONS



SAFER THE ENVIRONMENT HEALTHIER THE LIFE



INDEX

Company 4

Composition & Rewards 6

Floor Decking 7

• Shades 8

• Applications 9

• Fixing Detail 11

Wall Cladding 15

• Shades 16

• Applications 18

• Fixing Detail 21

Sunshade Louvers 25

• Shades 26

• Applications 28

• Fixing Detail 32

Pergola Patio 35

• Shades 36

• Applications 37

• Fixing Detail 39

Fascia Strips 43

• Shades 44

• Applications 45

• Fixing Detail 47

Mixed Applications 51

projects 53



There is no alternative to sustainability!

Founded on the same belief that connecting trade and sustainable practices transforms competitive landscapes compels us to change the way we think about products, technologies, processes and business models to meet emerging norms. By considering strict regulatory requirements as an opportunity for innovation rather than a cost, our offer is significant enough in the marketplace. It is an effort that ascends from industrial experience, from the steadiness that family ownership delivers and from the confidence in top quality people who make up our staff

ECO WOOD presents this catalogue with great humility and pride - the modesty of which comes with the class of the products we carry and the veracity of the clients we intend to serve

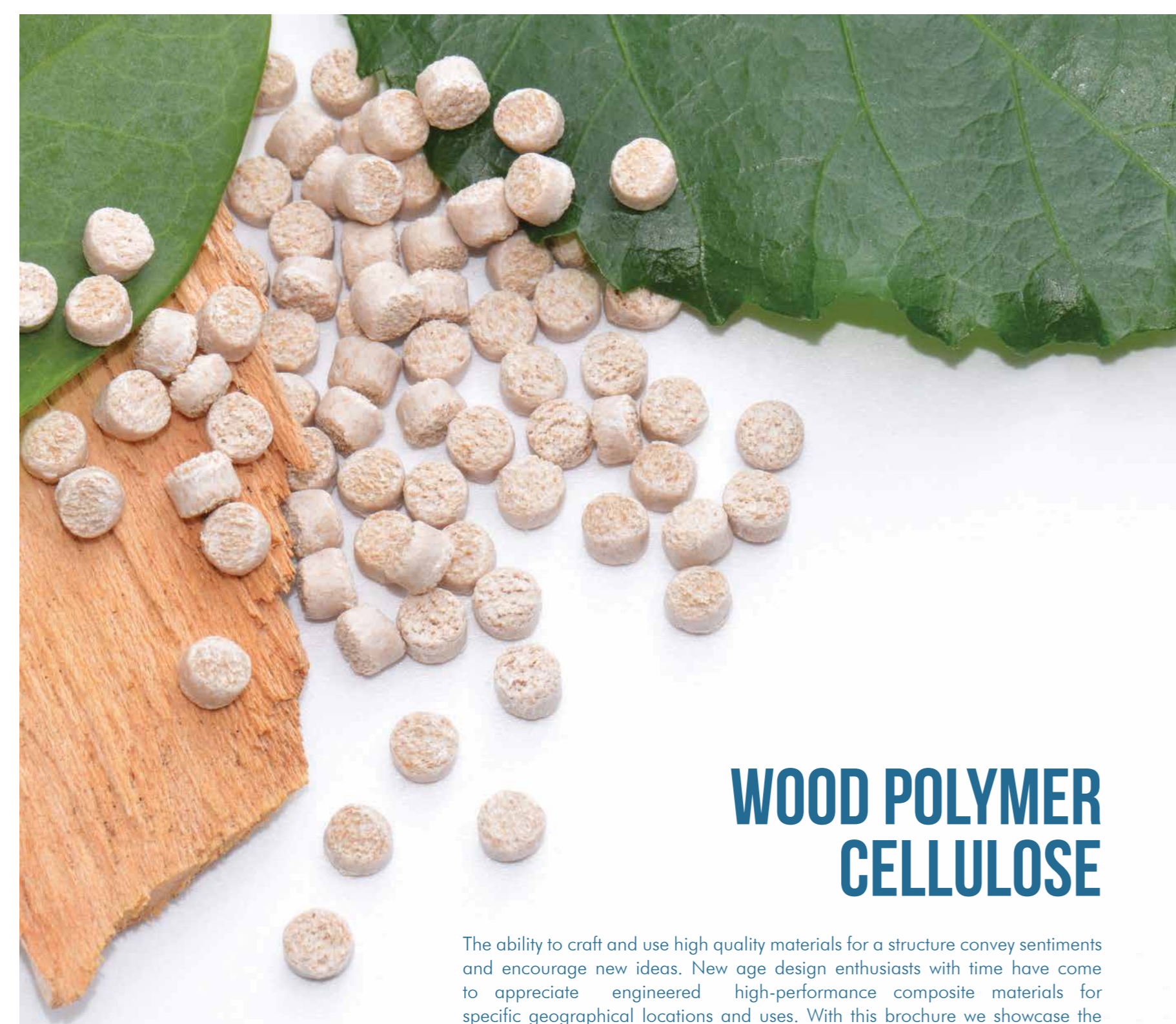

WOOD POLYMER CELLULOSE

The ability to craft and use high quality materials for a structure convey sentiments and encourage new ideas. New age design enthusiasts with time have come to appreciate engineered high-performance composite materials for specific geographical locations and uses. With this brochure we showcase the inventive and technical constituents of our WPC extrusions for outdoor and indoor use and simplify in understanding the importance of balancing utility, functionality and aesthetics – all at the same time!

COMPOSITION



With the sentiment of helping minimize environmental pollution, we've brought something that will withstand years of sun, rain, snow and big gatherings. These high-performance composite planks hold sturdy against natural elements; they resist fading from the sun and won't get mouldy after a rainstorm or give you splinters.

Our planks are manufactured primarily from a blend of recycled organic [Wasted Wood fibres] and plastic materials [post commercial recycled HDPE-High Density Polyethylene].

The organic material in these boards is recycled and reclaimed wood; the polyethylene is principally recycled shrink wrap and grocery bags - all of which would otherwise end up in a landfill.



Moisture-proof



UV Grade



Anti-static



All-weather Resistance

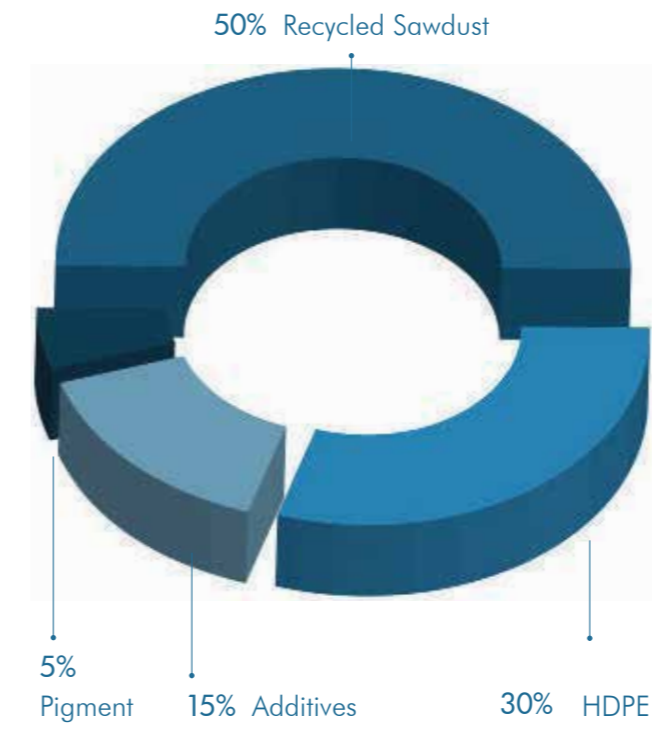

- Deep composite core for improved stability
- High performance grooves enhancing anti-skid features

FLOOR DECKING

SHADES

SN140W20
Solid Groove

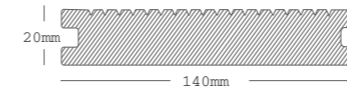

SN148W25(W)
Wood Grain

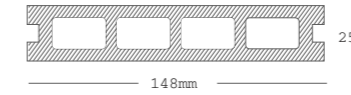

SN150W25(G)
Wide Groove

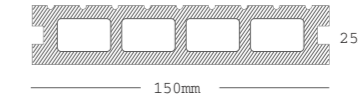

SN140LK50
Ending Plank

Ending Plank

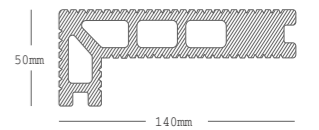

● Brown



● Chocolate



● Walnut



● Grey

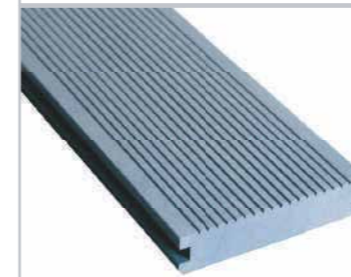

Available shades:

- Grey
- Walnut
- Chocolate
- Brown



Floor Decking



Raised Access Flooring System

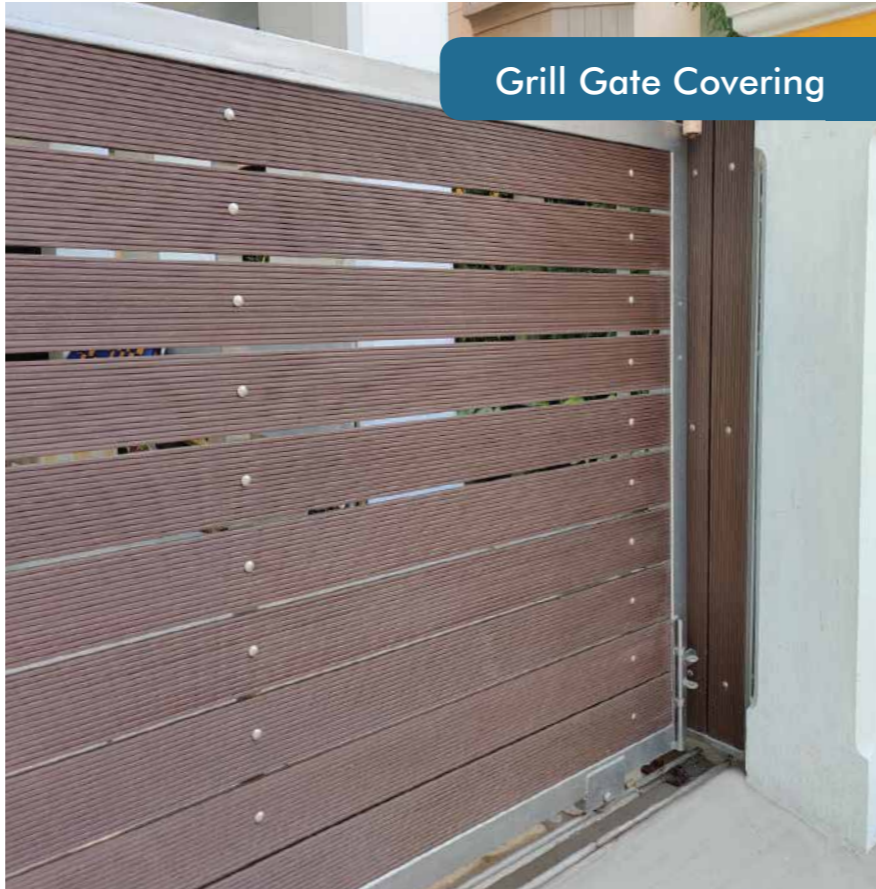
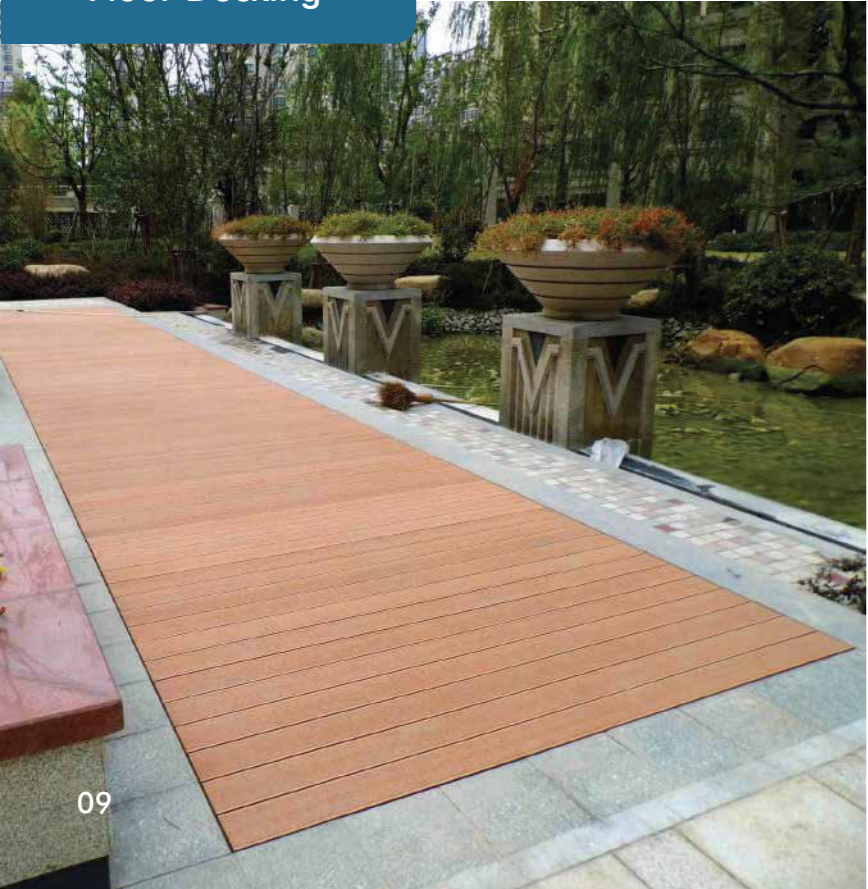

Grill Gate Covering

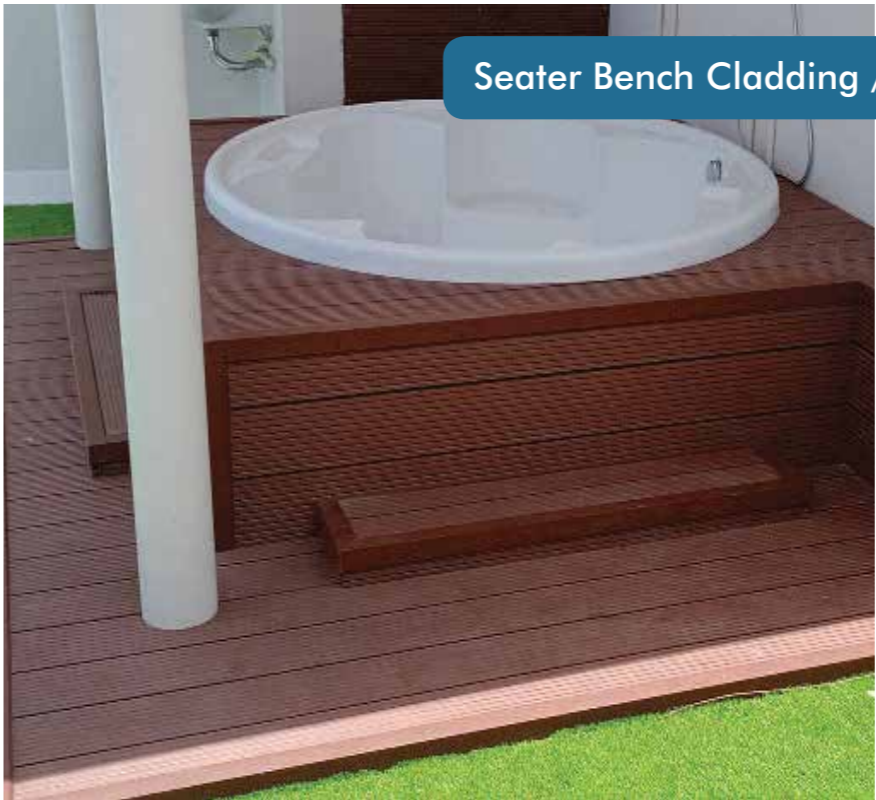

Seater Bench Cladding / Planter Box Cladding

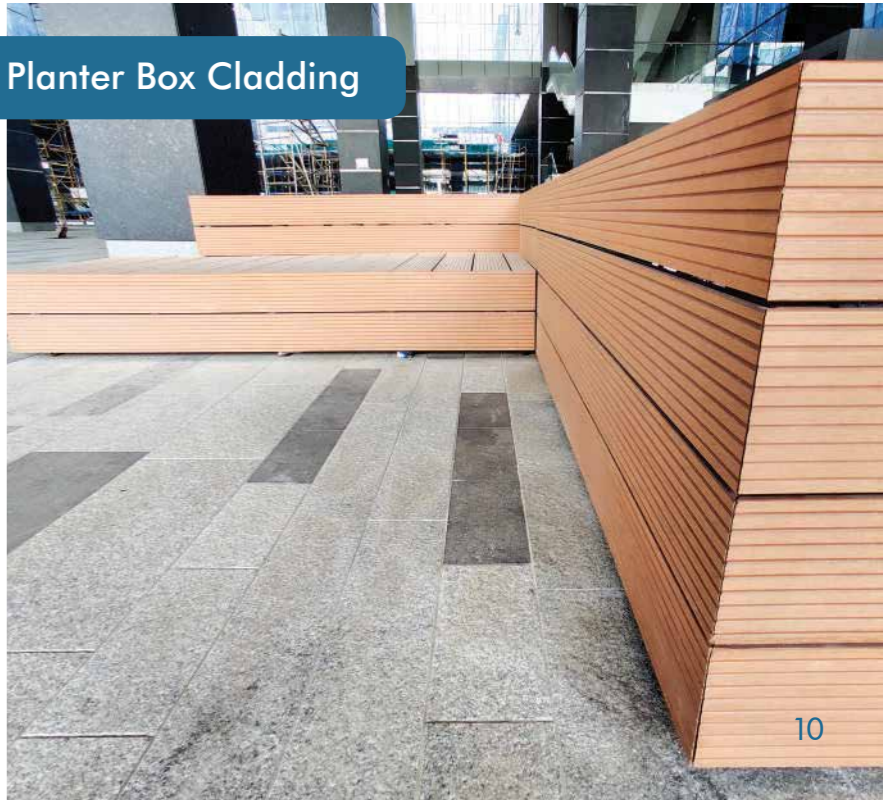

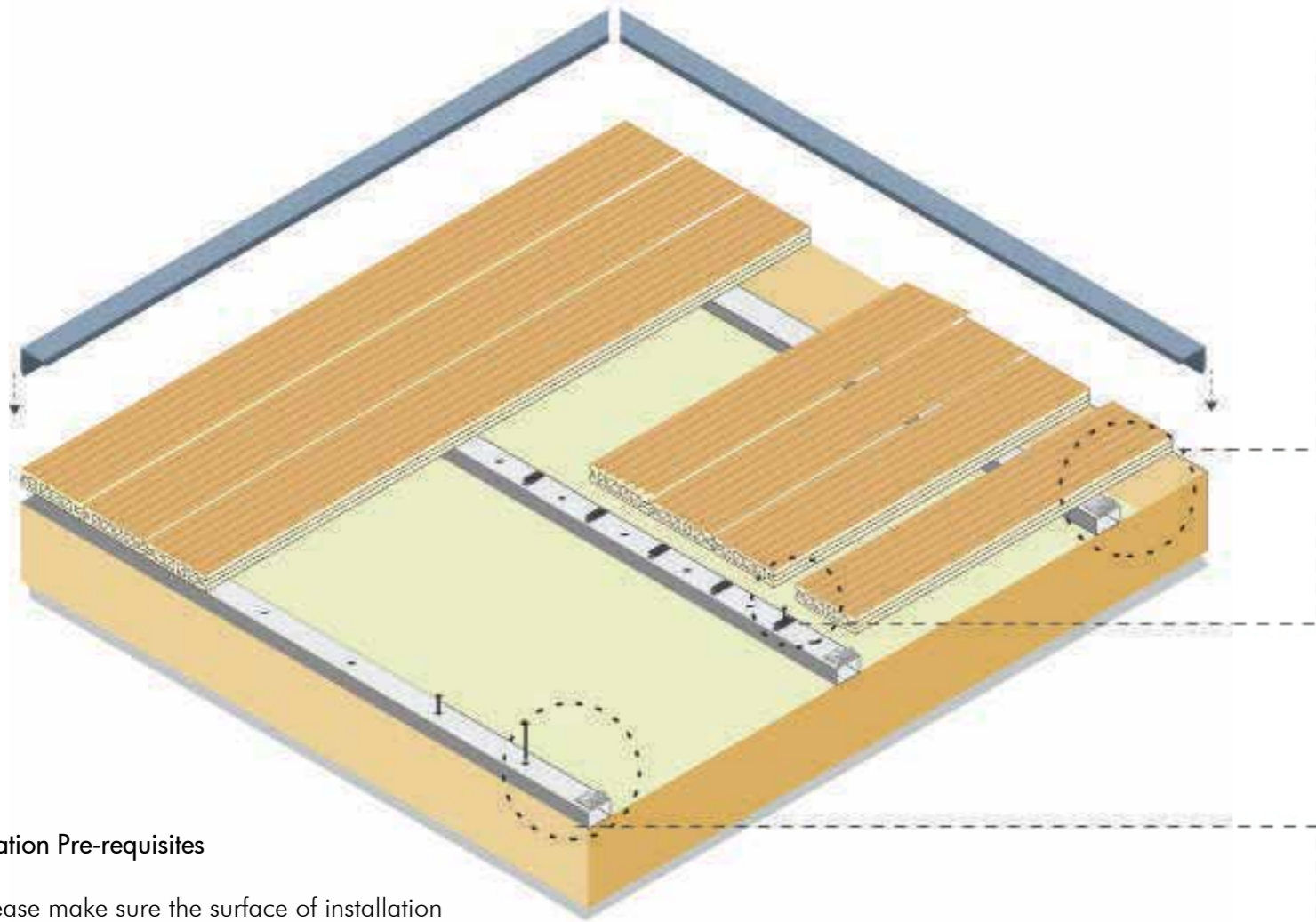

Installation Pre-requisites

1. Please make sure the surface of installation is smooth. In case of an unlevelled site, the loose soil should be compressed with a roller or thumper. Apply concrete to the area or work out the application area using frames, weed control fabric and concrete slabs for effective load spreading foundation.
2. Plan ahead in regards to the inclination details to facilitate rain escape/drainage.

Gapping Details (Above 4.5 ° C) - For Expansion & Contraction

Material	Width-to-Width	Abutting	Width-to-Wall End
Joist/Runner	18" [458mm]	6mm	10mm
Decking Planks	4mm - 6mm	3mm - 5mm	6mm - 12mm

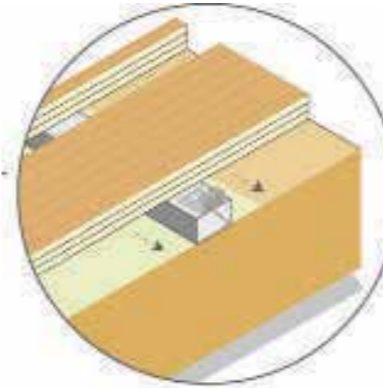

Starter / End SS Clips

Insert starter clips on edge of the joists and secure them with screws. Important: The first plank **MUST** be straight and well secured.

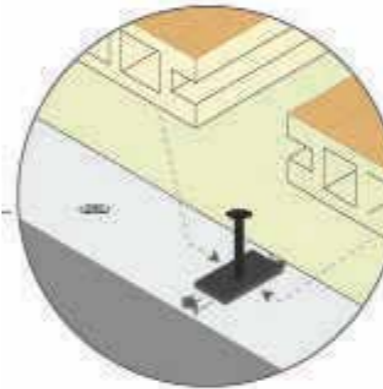

Interlocking ABS clip mechanism

Slide the next plank into place, making sure the clip fits into the groove. Install the next clip on the other side of the plank in the same manner. **DO NOT** fully screw the clips until the next plank is in place, tightening down each row after the plank that follows is in place. Insert the decking clip or fastener into the grooved edge of the plank and lightly screw it.



Runner/Frame

Drill and secure the aluminium tube sections with rubber gaskets underneath for drainage purpose to the concrete slab surface using MS brackets or expansion screws.

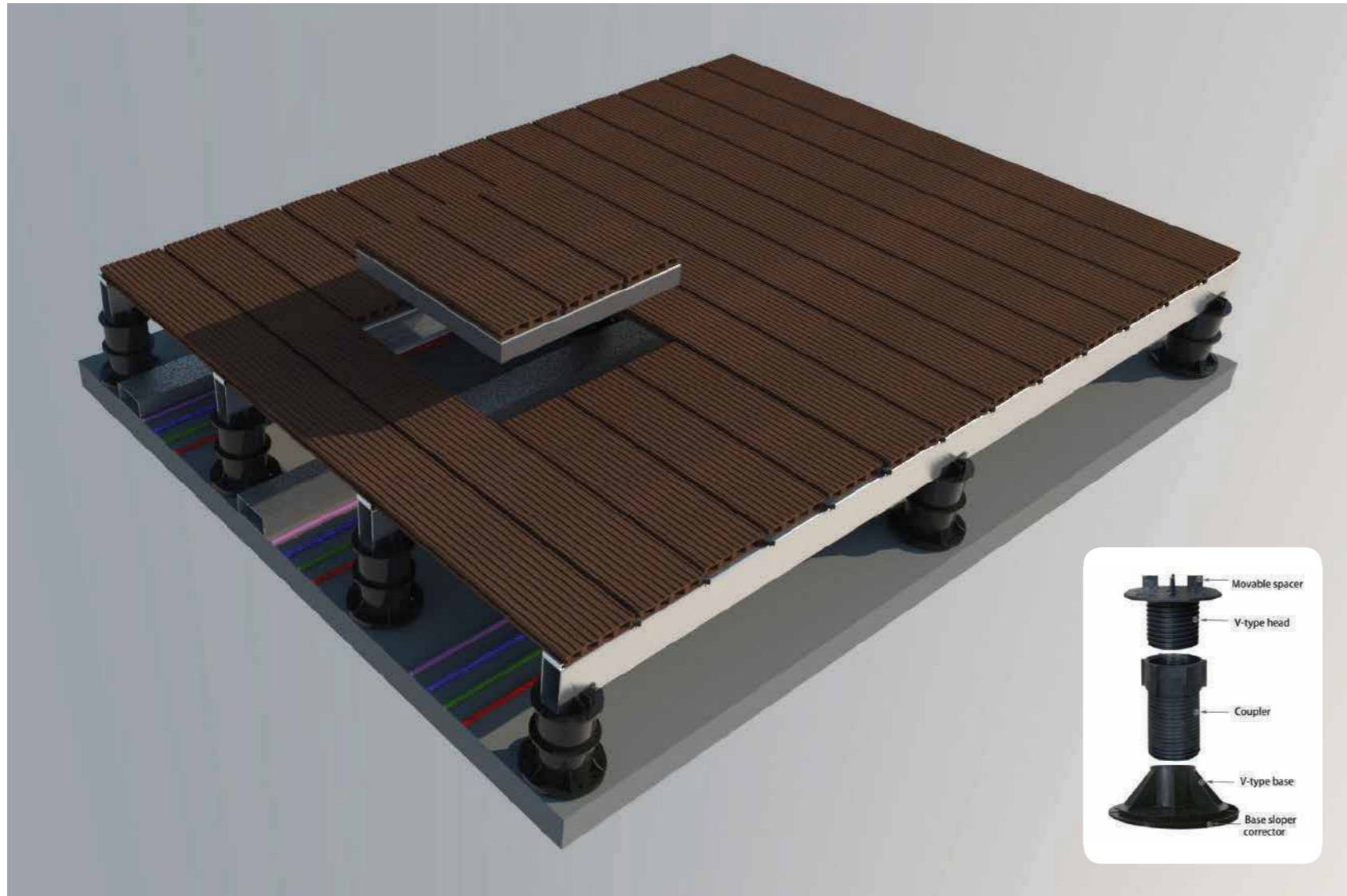

MECHANISM

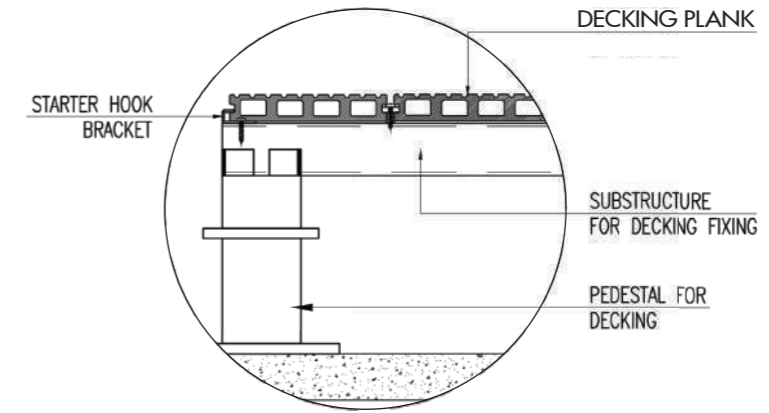

TYPICAL DECKING FIXING DETAIL

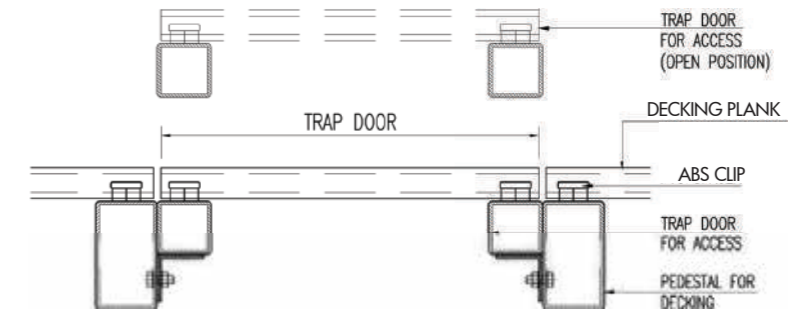

TYPICAL TRAP DOOR DETAIL

HARDWARES & ACCESSORIES



PEDESTAL

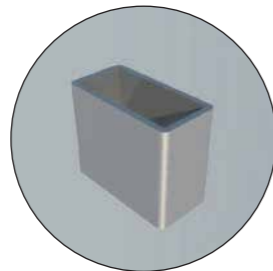

BOX SUBSTRUCTURE

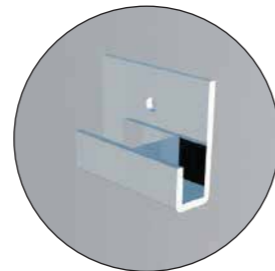

STARTER BRACKET



ABS INTERLOCK CLIP

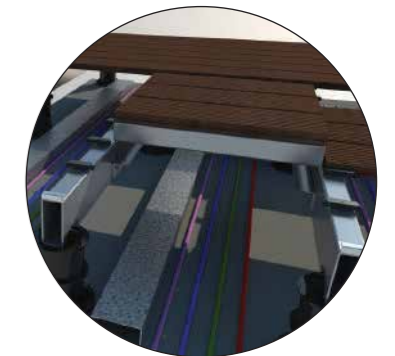
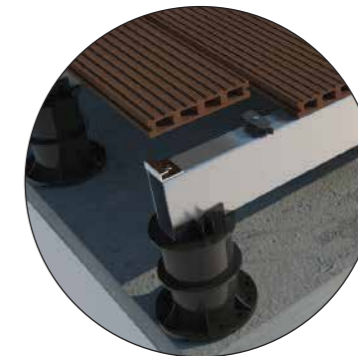
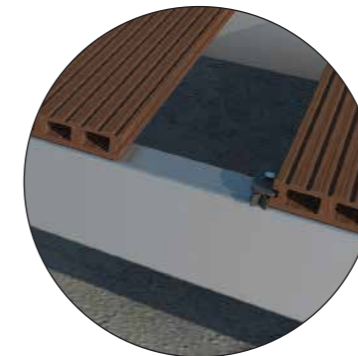
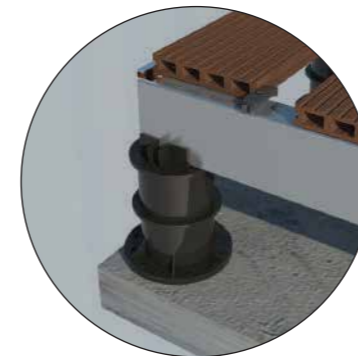

WALL CLADDING

SHADES

SN156W21

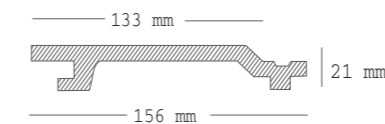

SN146W16

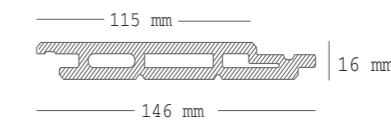

● Brown



● Chocolate



● Walnut



● Grey

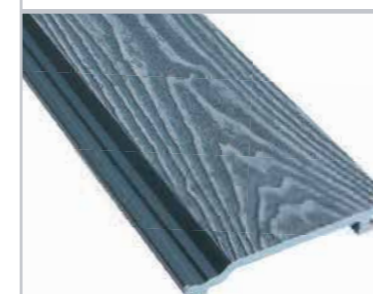

*Available in 2.9m length; subject to order upto 5.8m.

LOUVERED CLADDING (FLUTED PANELS)

APPLICATIONS

SN218W28

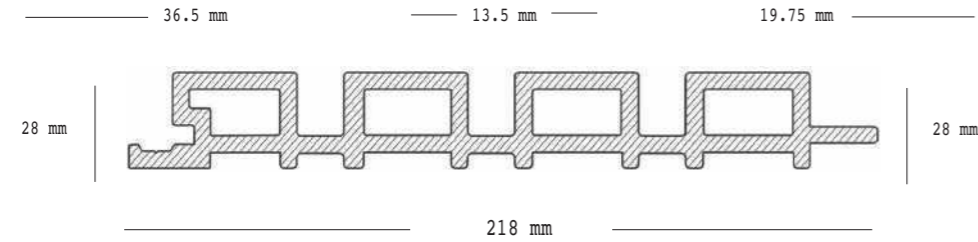

CO-EXTRUSION

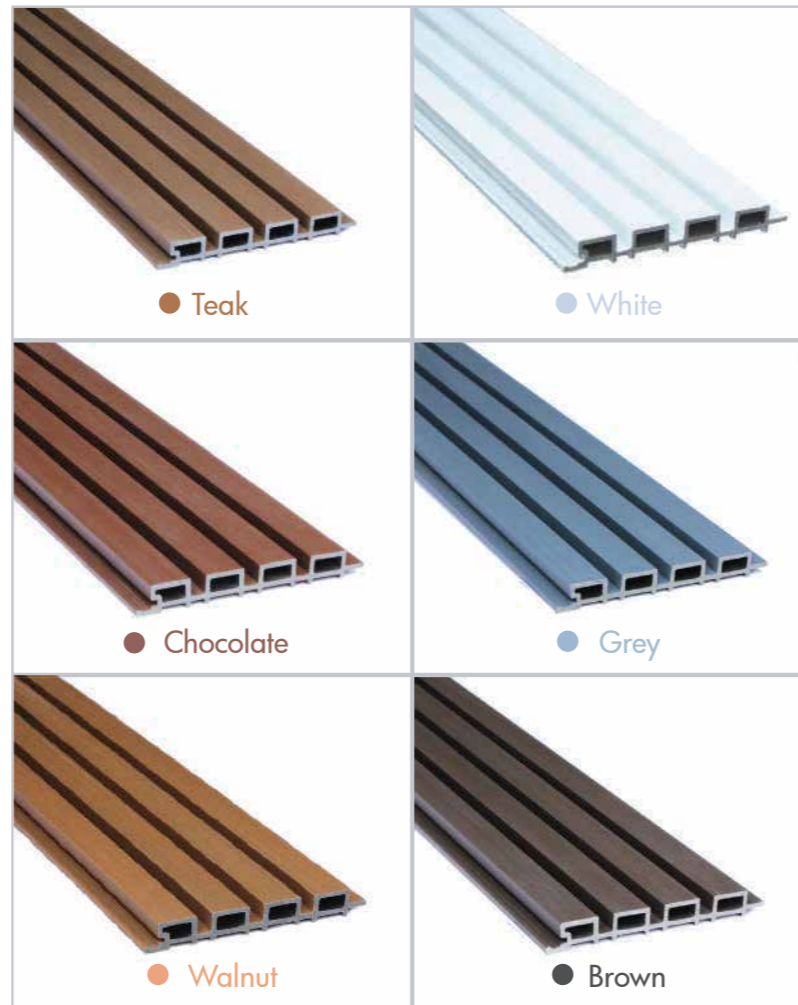

HOMOGENOUS

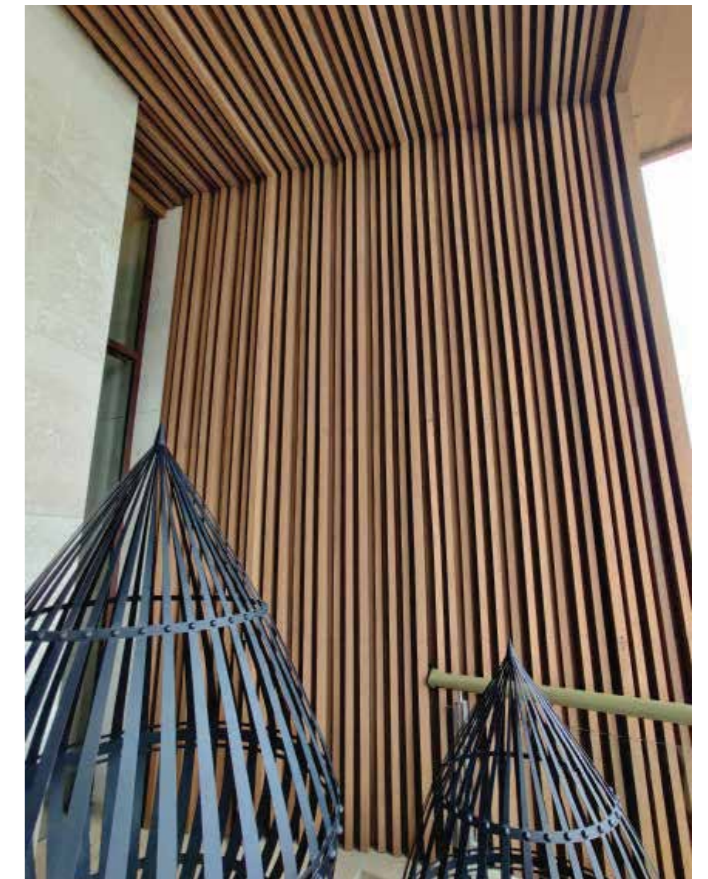



Ventilated Facade Cladding



Wall Cladding

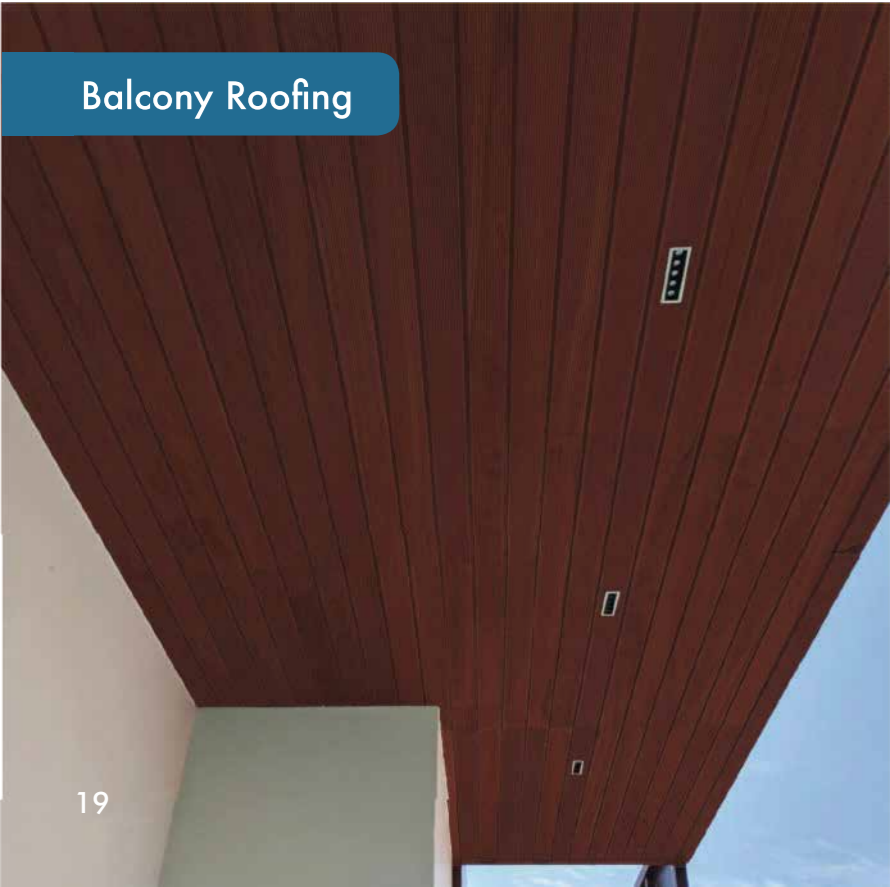

Balcony Roofing



Prefab Shed Cladding

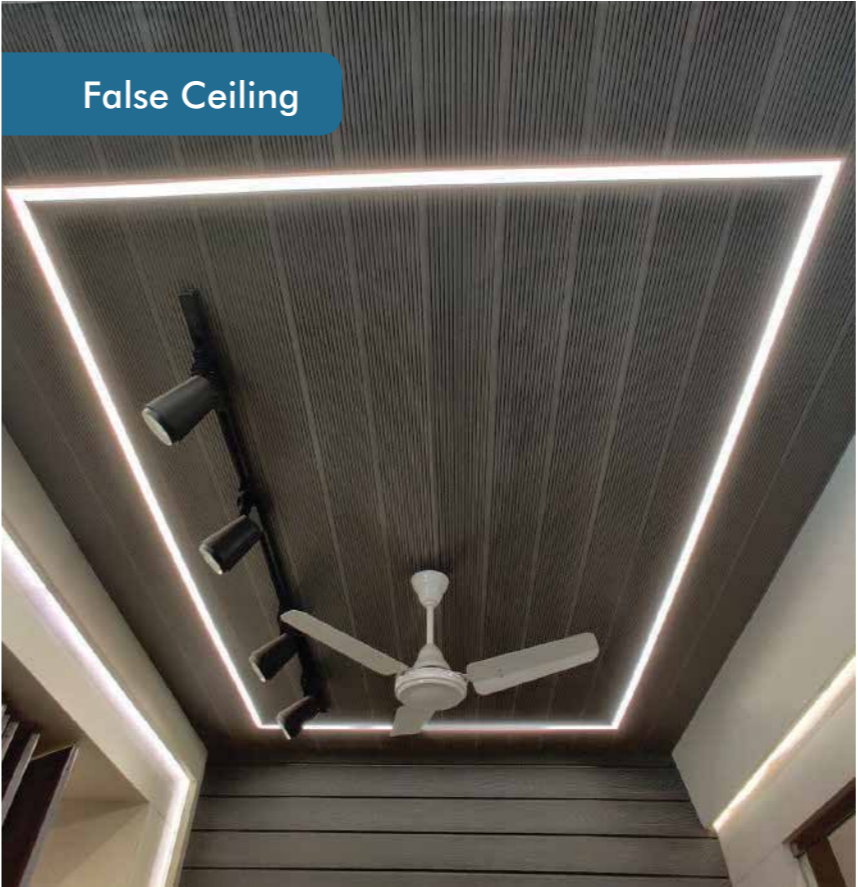

False Ceiling

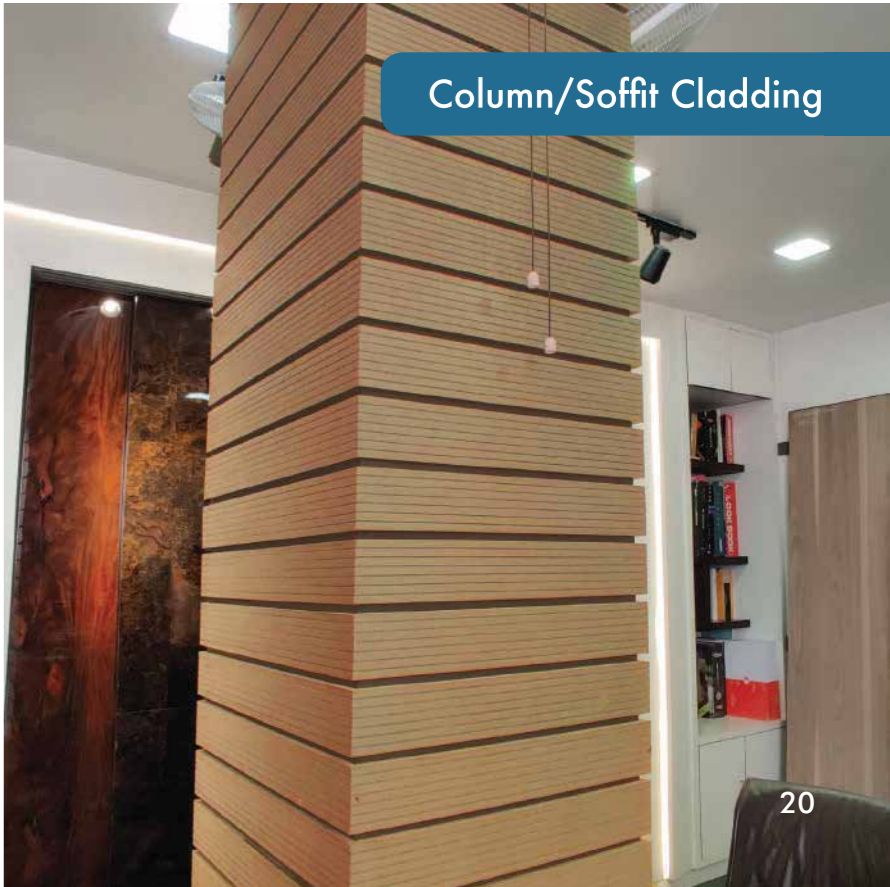

Column/Soffit Cladding

FIXING DETAIL | ELEVATION CLADDING

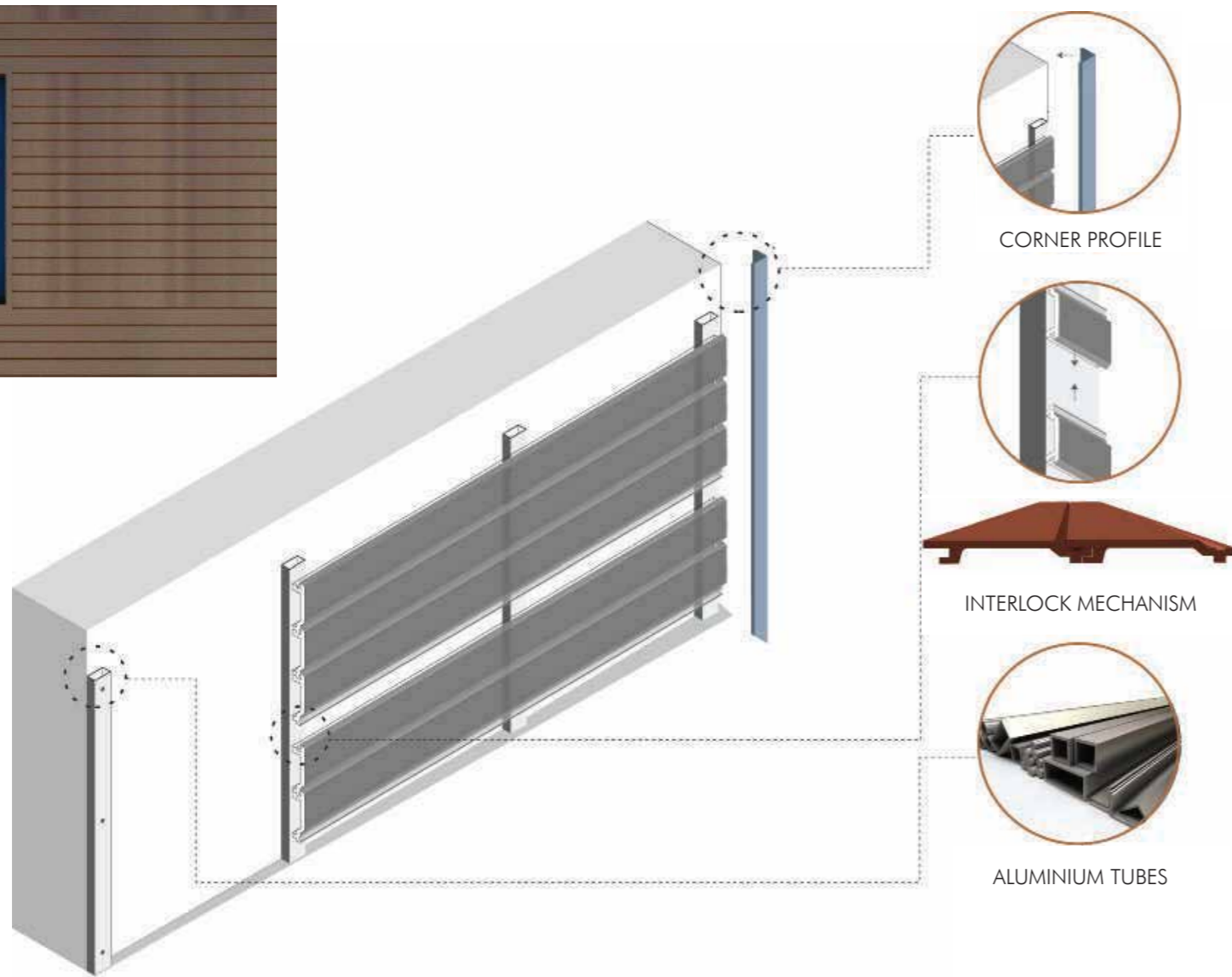
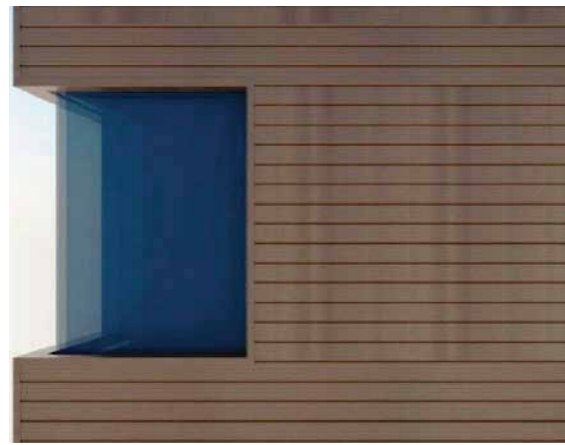

MECHANISM

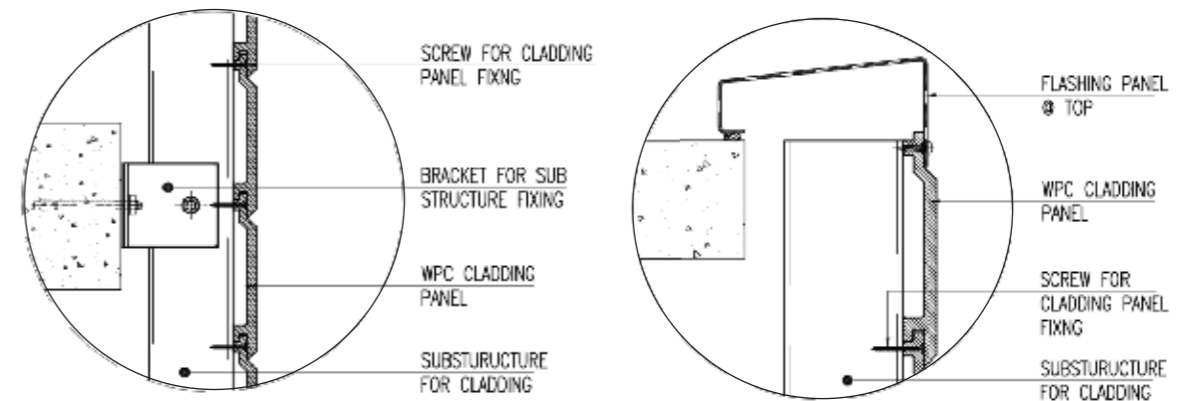
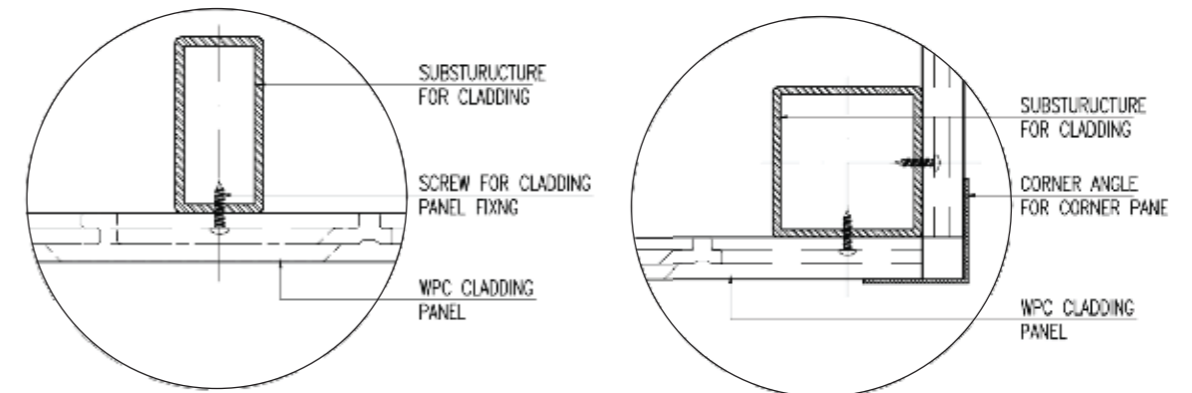

HARDWARES & ACCESSORIES

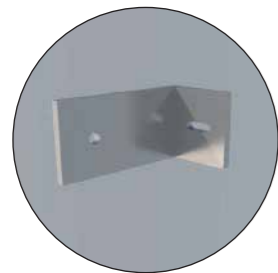

BRACKET

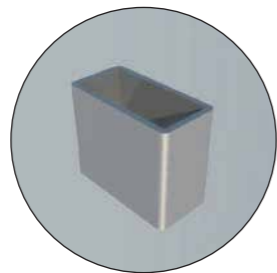

RECTANGULAR MS TUBE



EXPANSION BOLT

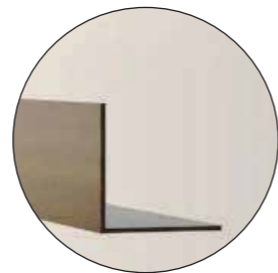

CORNER ANGLE

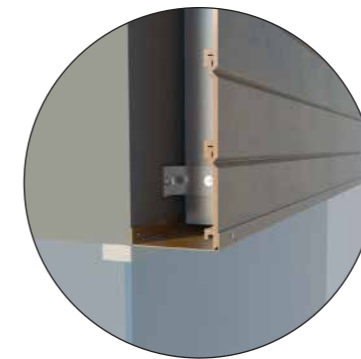



- VIABLE CEILING FEATURES**
- Fan
 - Smoke Alarm
 - Recessed/Exposed track lights
 - Spot/Decorative lights
 - Ceiling mounted Air-con
 - Other designer elements

MECHANISM

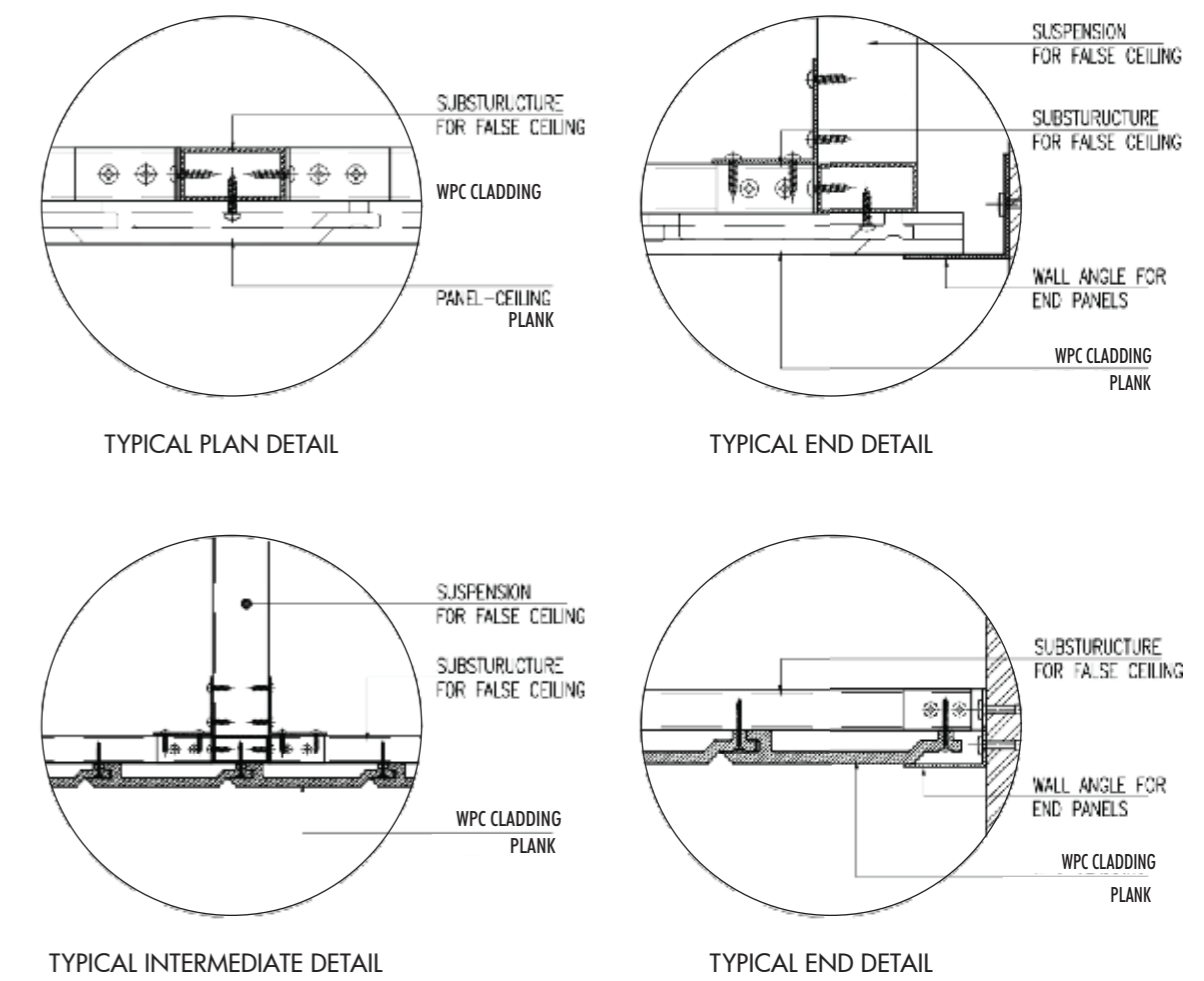

HARDWARES & ACCESSORIES

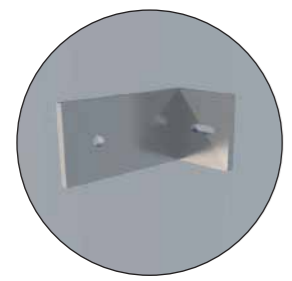

BRACKET

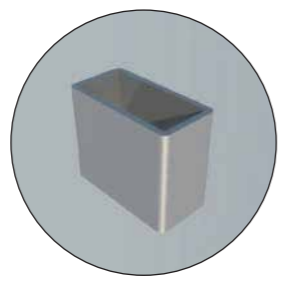

RECTANGULAR ALUMINIUM TUBE



EXPANSION BOLT

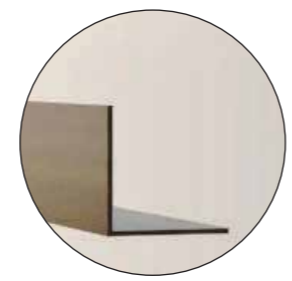

CORNER ANGLE



SUNSHADE LOUVERS

SHADES

● Mahogany

● Walnut

SN60W24

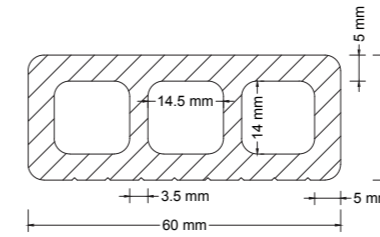

SN60W40

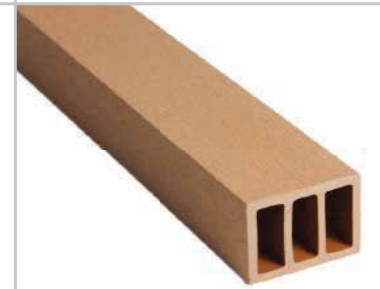
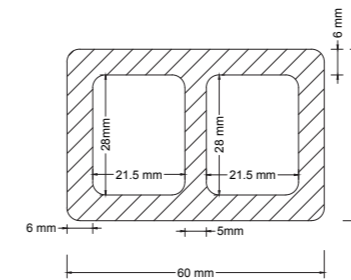

SN60W60

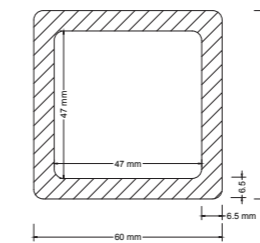

SN100W50

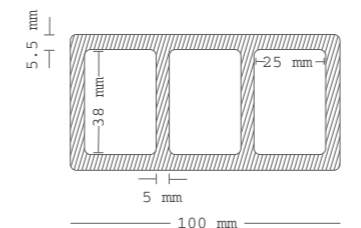

*Available in 2.9m length; subject to order upto 5.8m.

● Mahogany

● Walnut

SN143W35

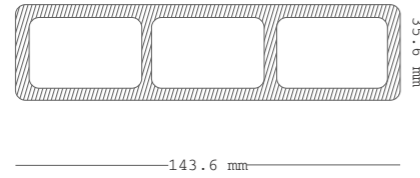

SN146W50

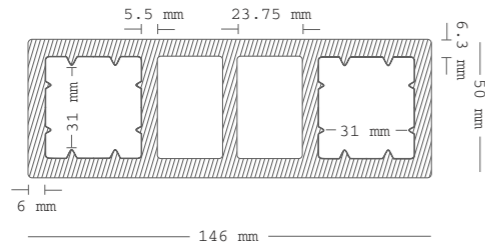

SN185W39

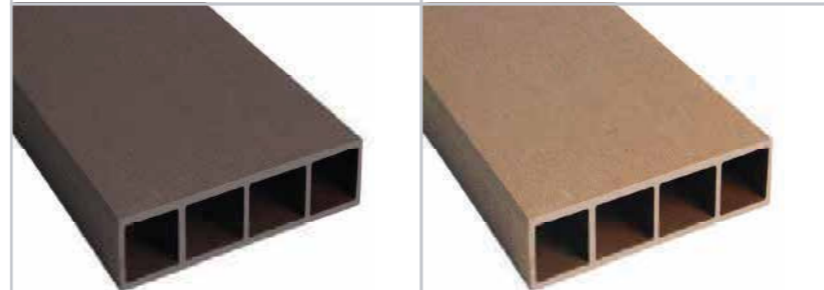
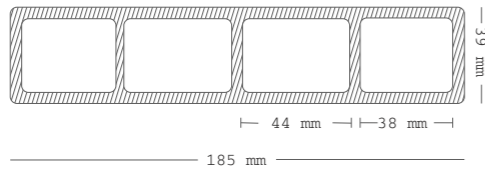

SN160W80

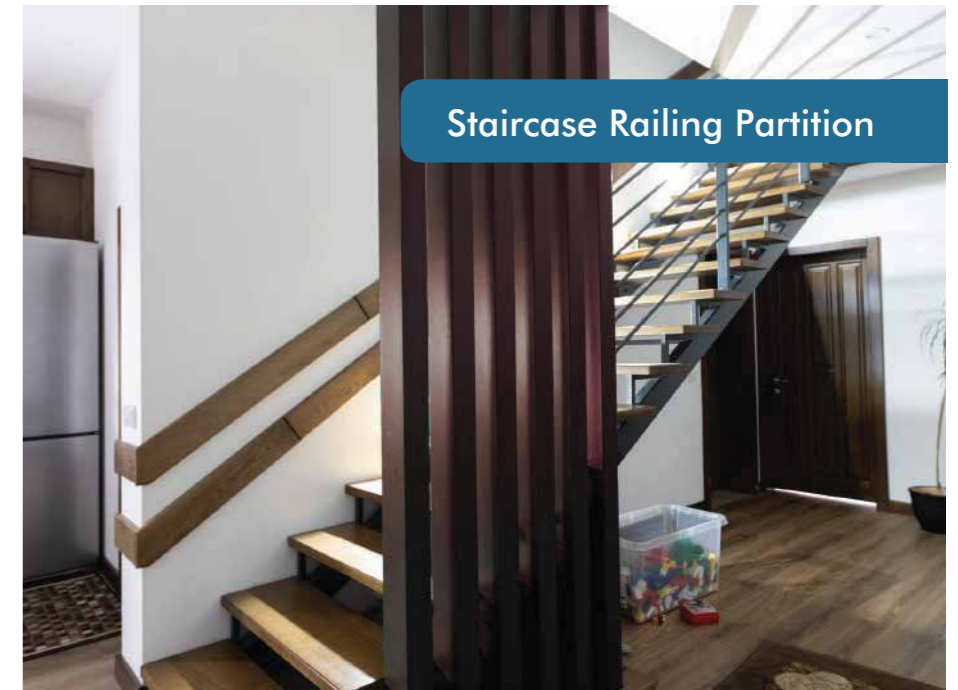
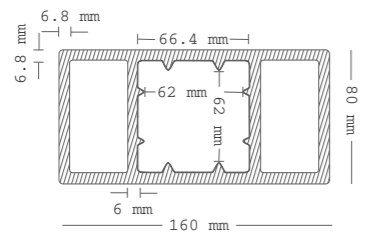



Roofing Sunshade

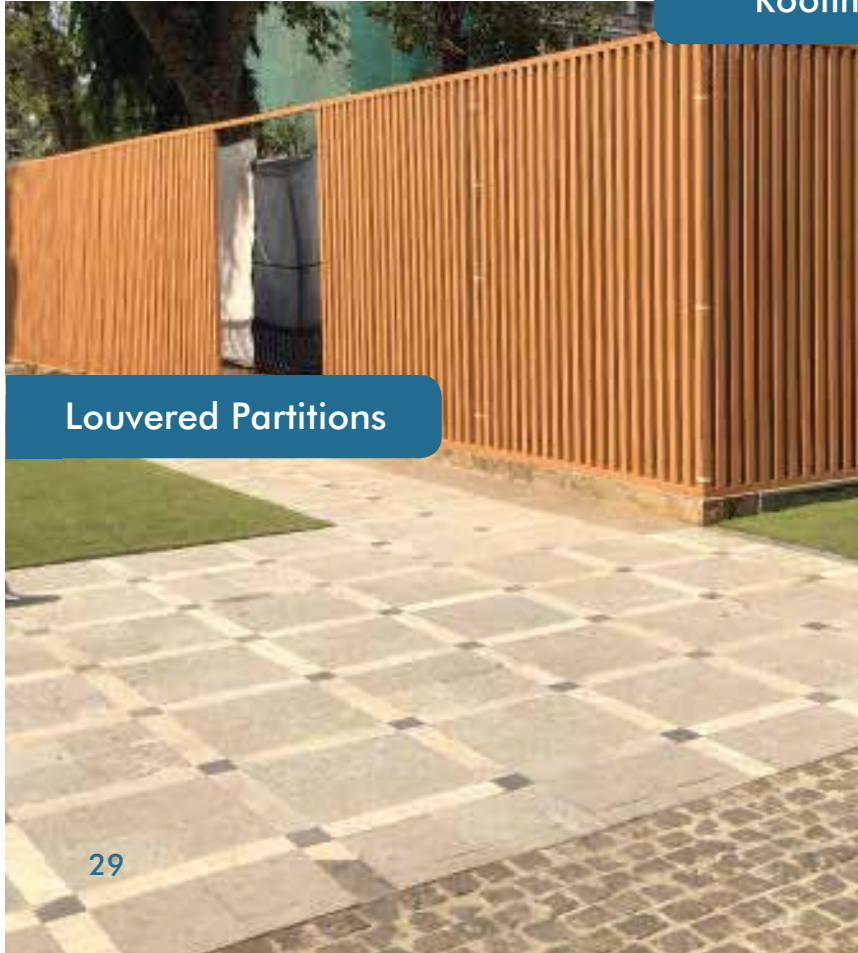
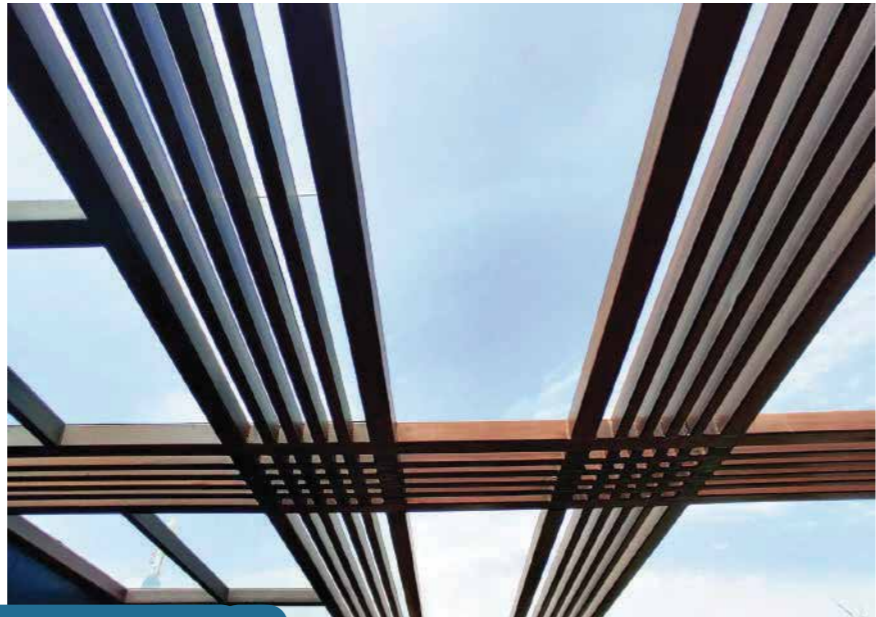

Louvered Partitions



Shop Front Screening

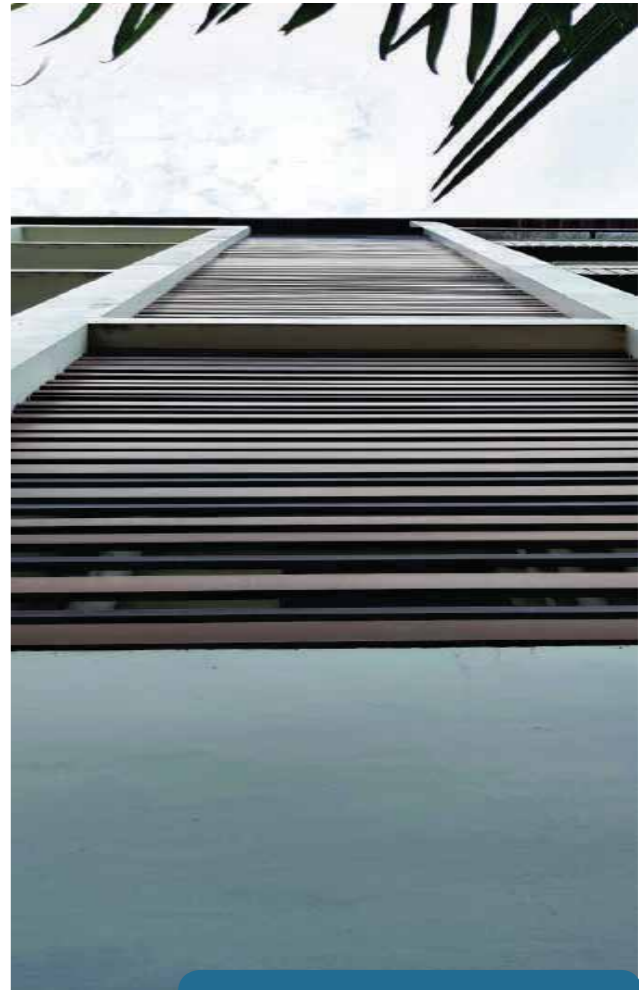

Elevation Sunshade



APPLICATIONS

FIXING DETAIL | BAFFLE CEILING SYSTEM



Baffle Ceiling System



MECHANISM

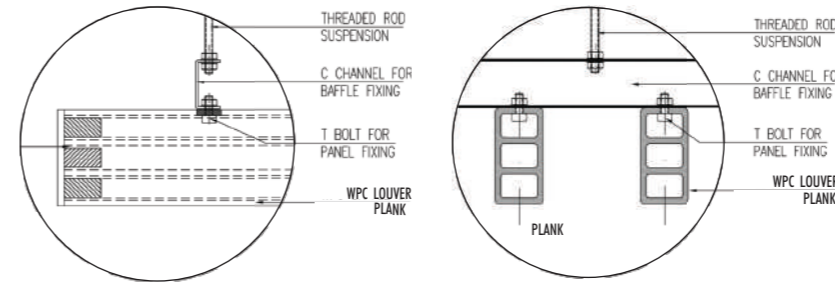

TYPICAL FIXING DETAIL - A

TYPICAL FIXING DETAIL - B

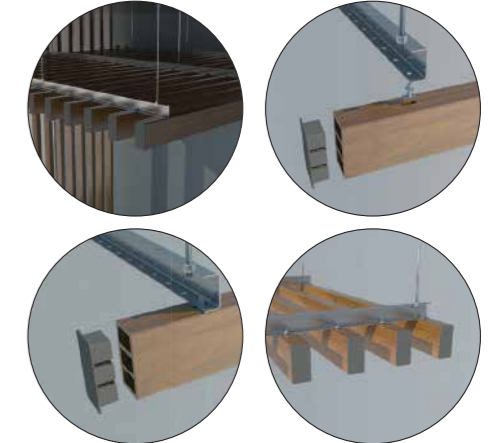

HARDWARE & ACCESSORIES

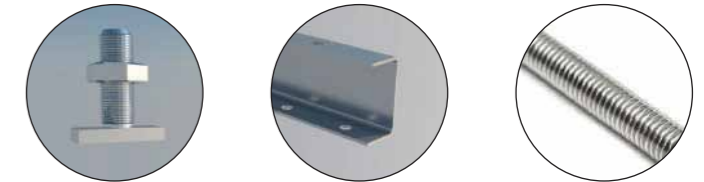

T BOLT

BAFFLE FIXING CHANNEL

THREADED ROD

PARTITION SYSTEM

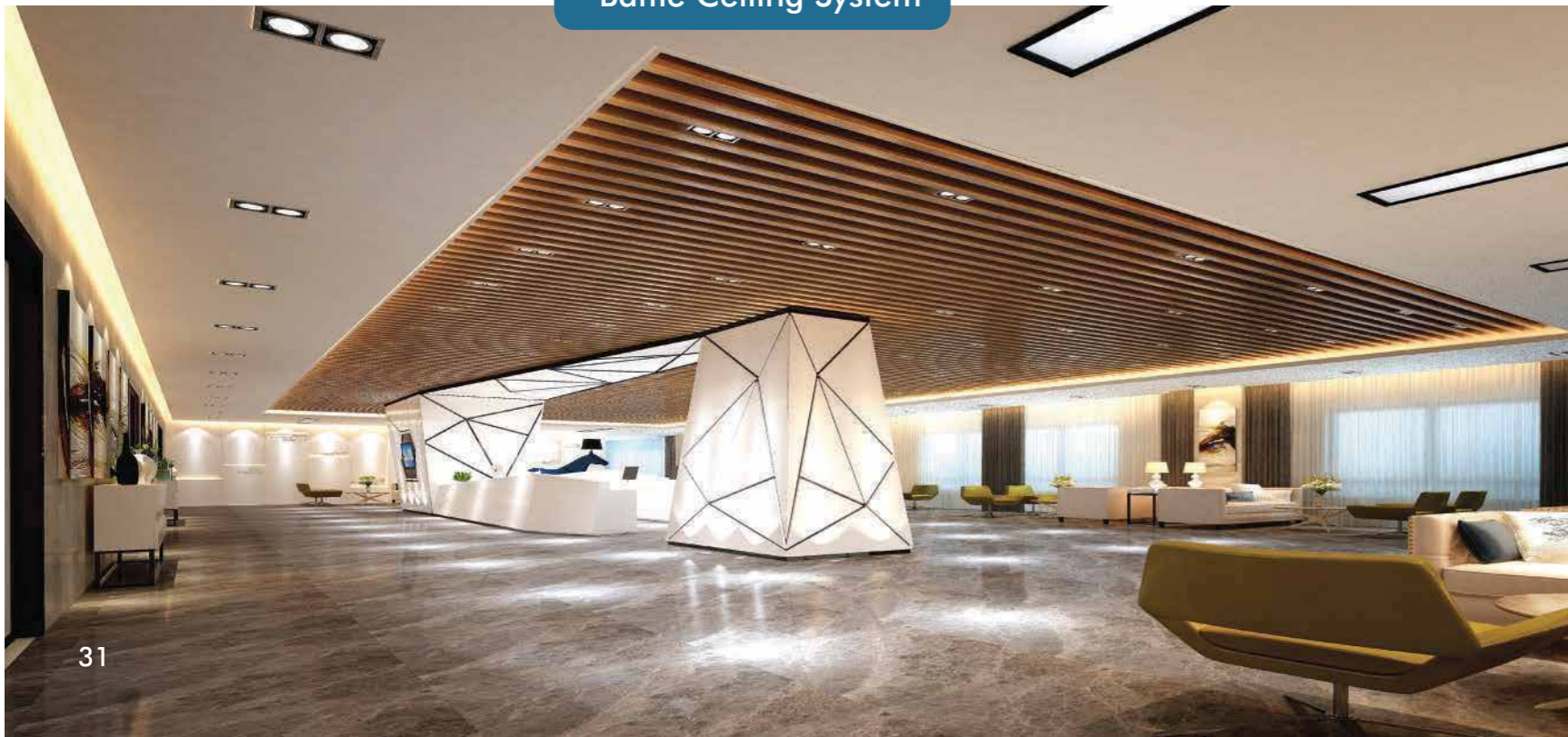

MECHANISM

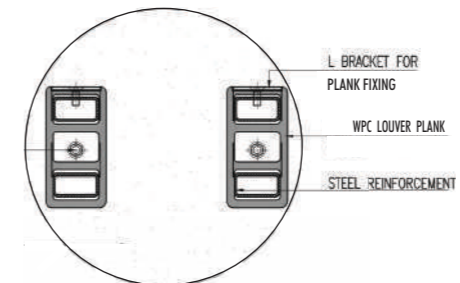

HORIZONTAL FIXING DETAIL

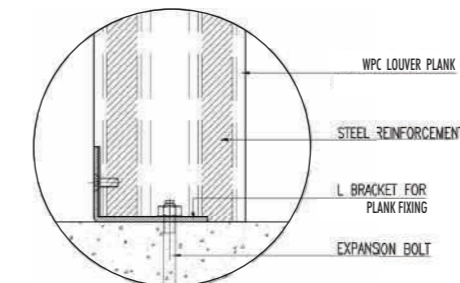

VERTICAL FIXING DETAIL



HARDWARE & ACCESSORIES



L BRACKET

ALLEN BOLT

EXPANSION BOLT

HORIZONTAL



MECHANISM

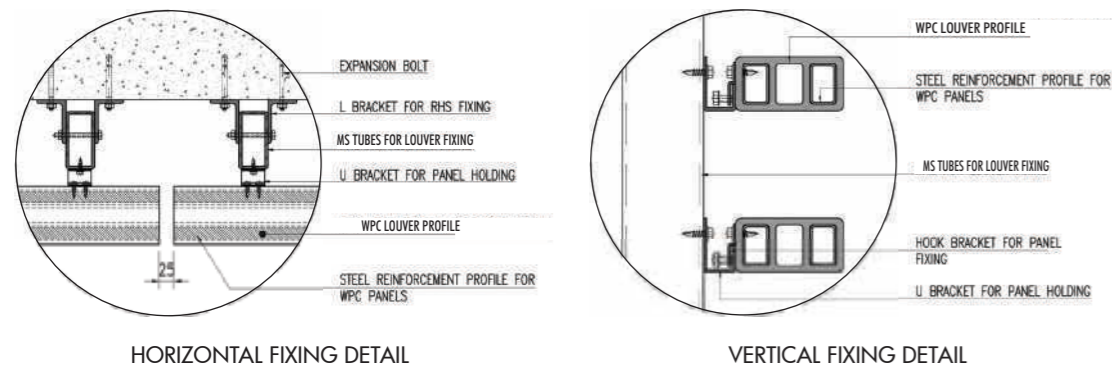

VERTICAL - SEAMLESS

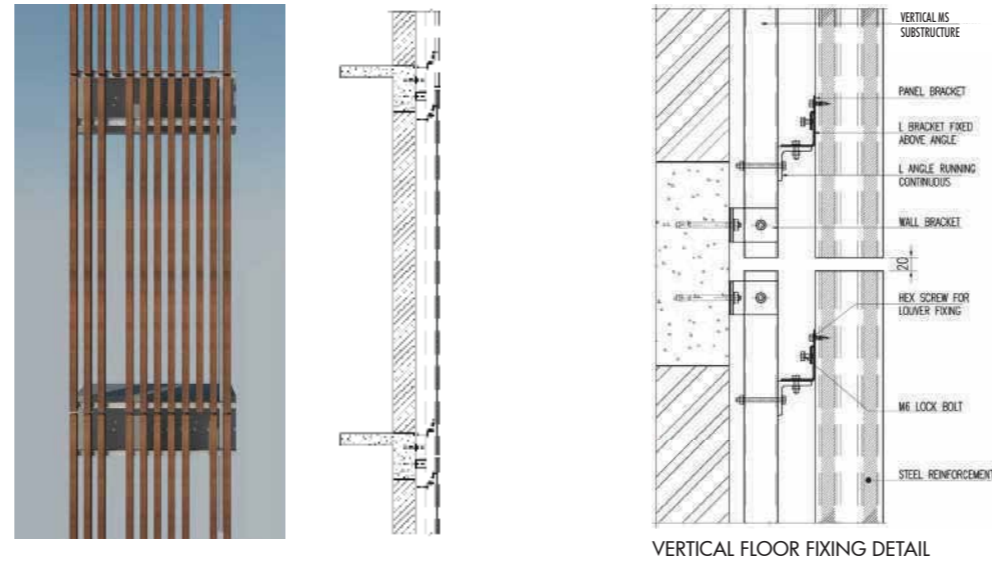
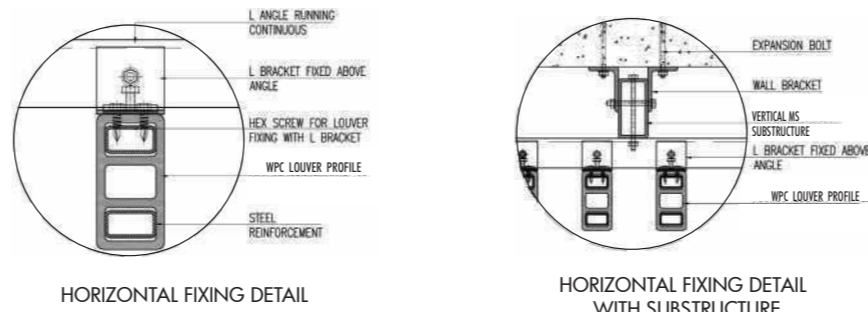

VERTICAL - BEAM TO BEAM

MECHANISM

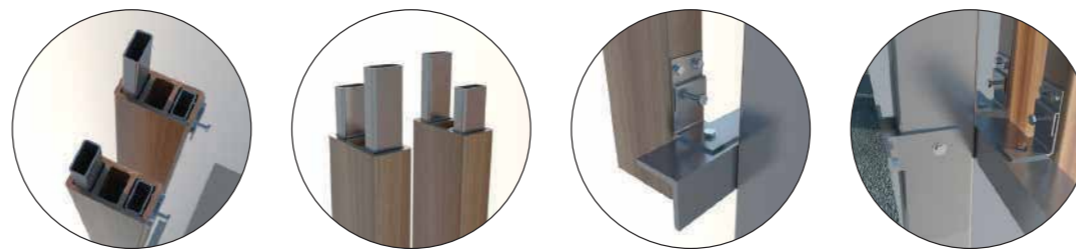
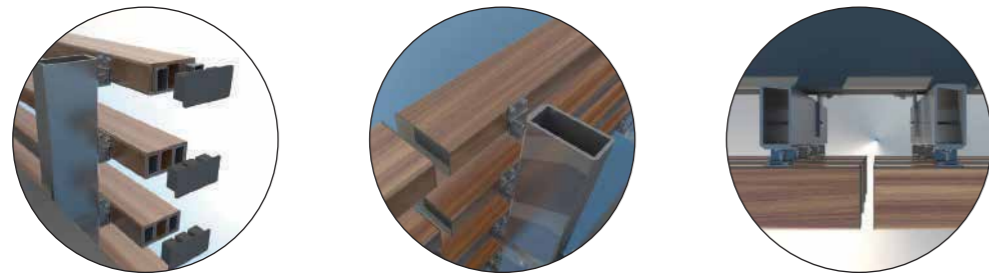
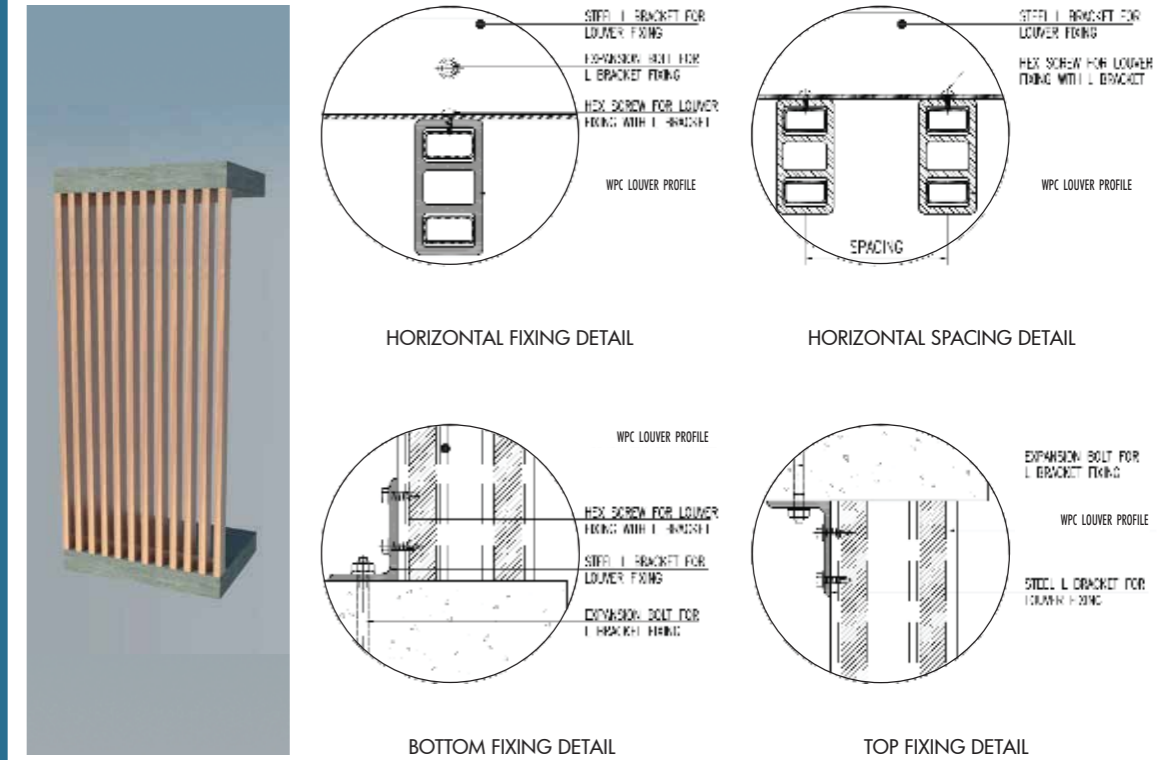

HARDWARE & ACCESSORIES



EXPANSION BOLT



PANEL BRACKET



BOLT NUT



L BRACKET



WALL BRACKET

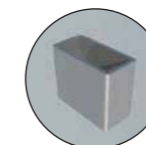

RECTANGULAR MS TUBE REINFORCEMENT



HEX SCREW #8X19



U BRACKET

SHADES

PERGOLA SYSTEM

SN150W150
Post/Column

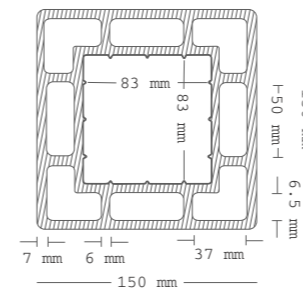

SN160W80
Beam

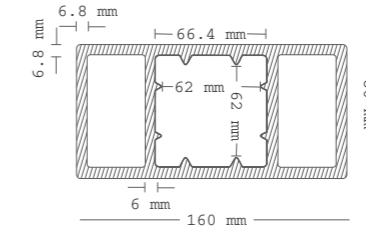

SN146W50
Rafter/Fin

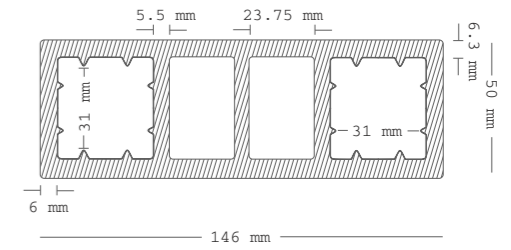

● Mahogany

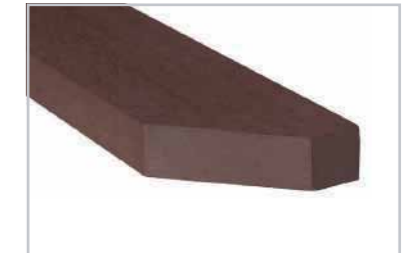

● Walnut

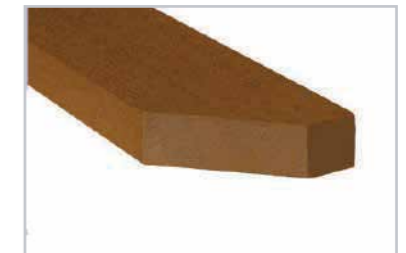

CUSTOMIZED COLUMNS

● Mahogany



SN90W90

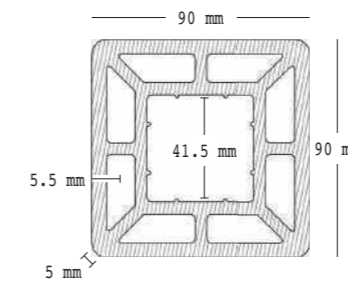

● Walnut



● Mahogany

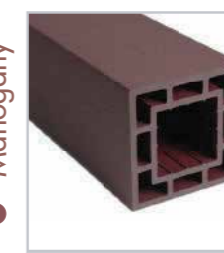

SN120W120

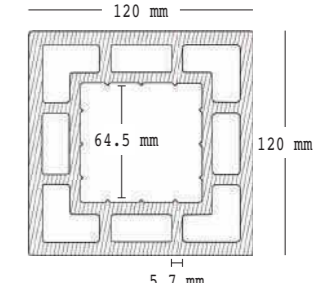

● Walnut



*Available in 2.9m length only.

PERGOLA PATIO

APPLICATIONS | EXTERIORS



Terrace Pergola



Balcony/Outdoor Sit-out Covering



Cabana

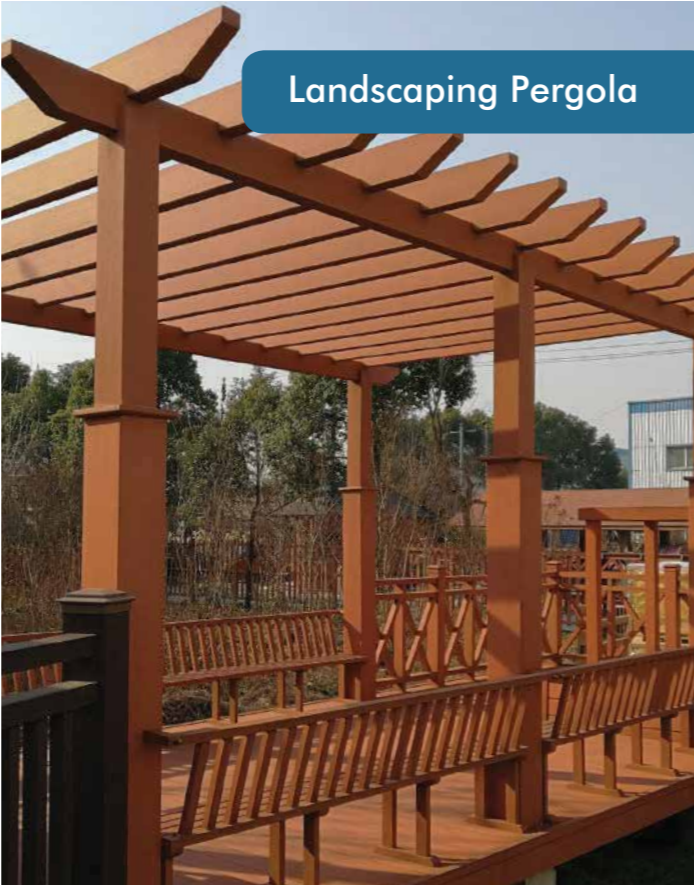

Landscaping Pergola

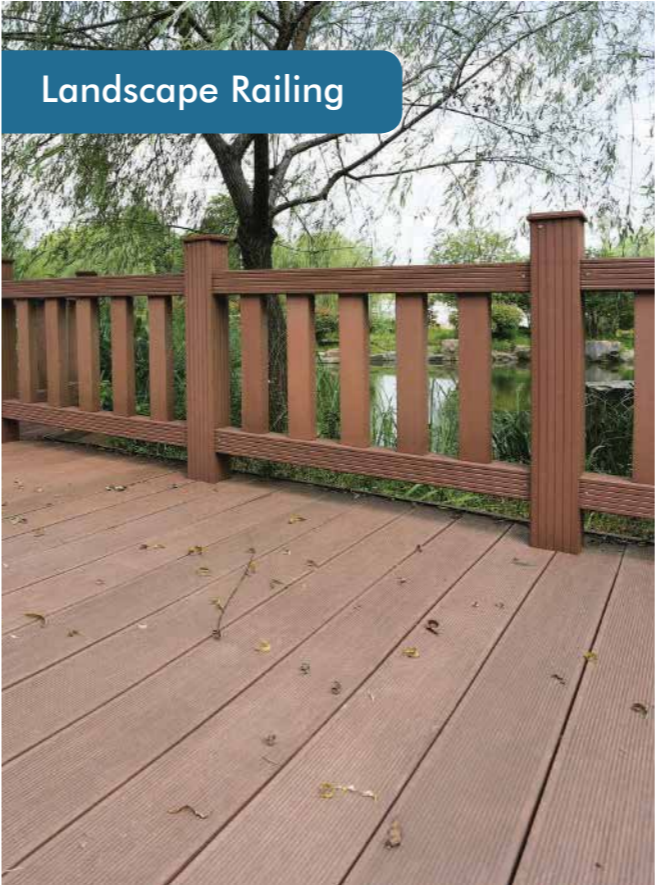

Landscape Railing



Designer Trellis Pergola

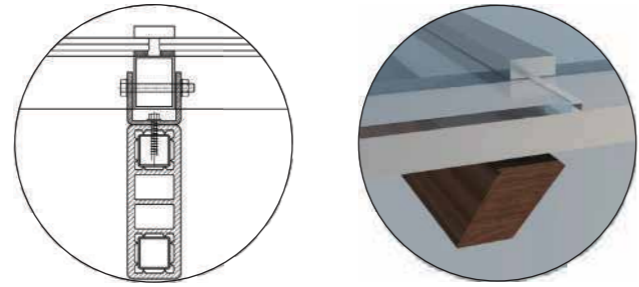

OPTIONAL GLASS ROOFING DETAIL

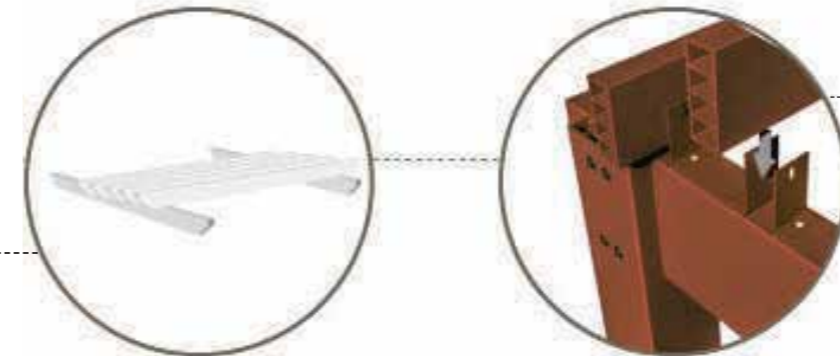
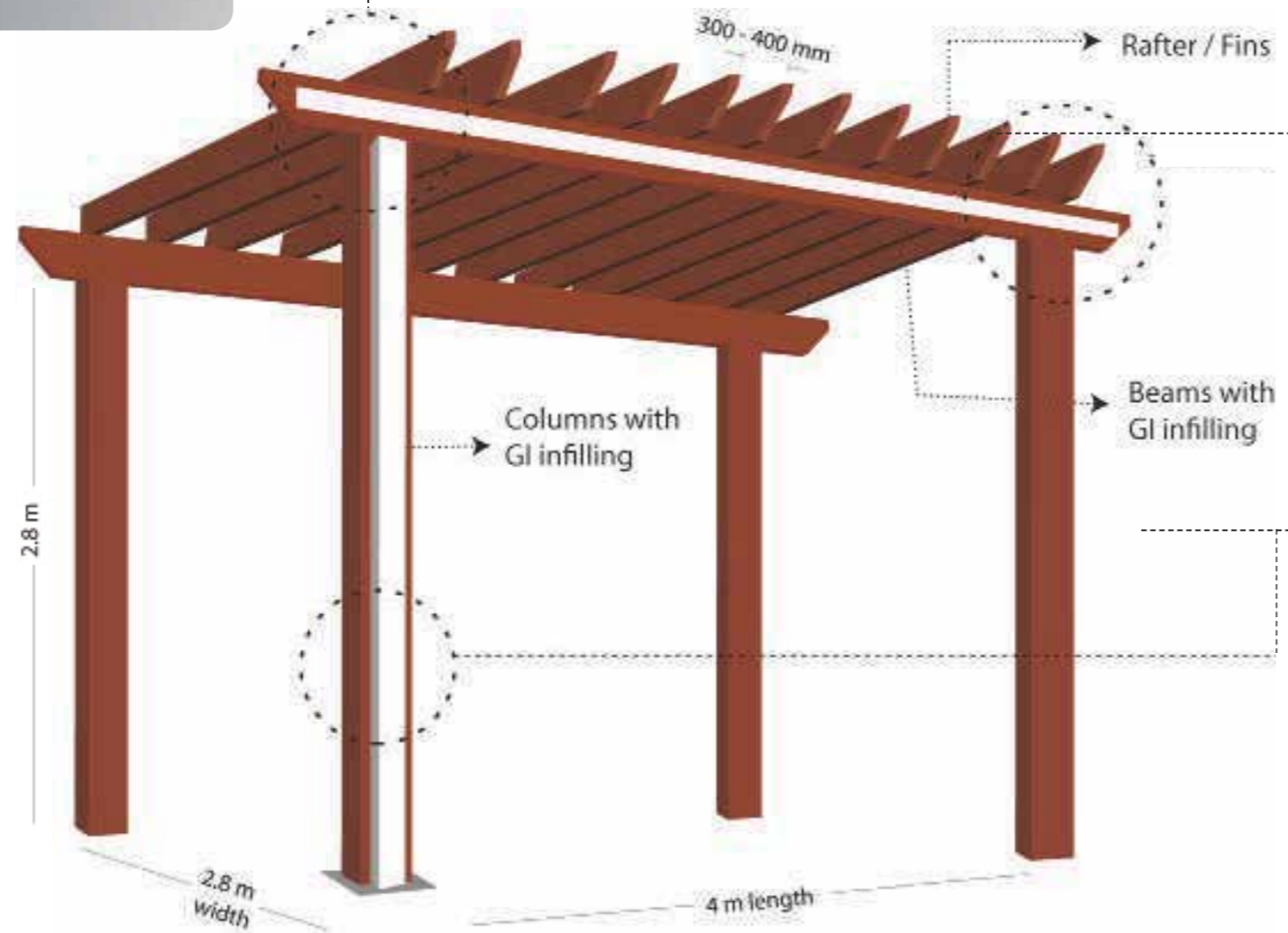

Rafters/Fins

Place the fins as per the marked positions with the steel tube inserted for better strength and rigidity.

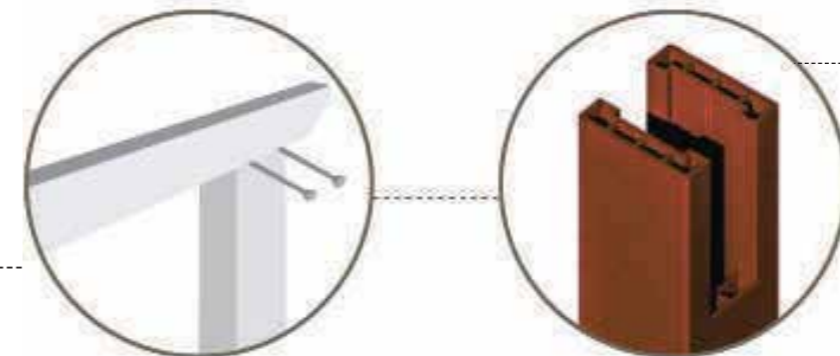

Beams

Clamp the beams in place and check if they are level with the all the posts' length and width support. Make appropriate cut-outs for the emplacement.

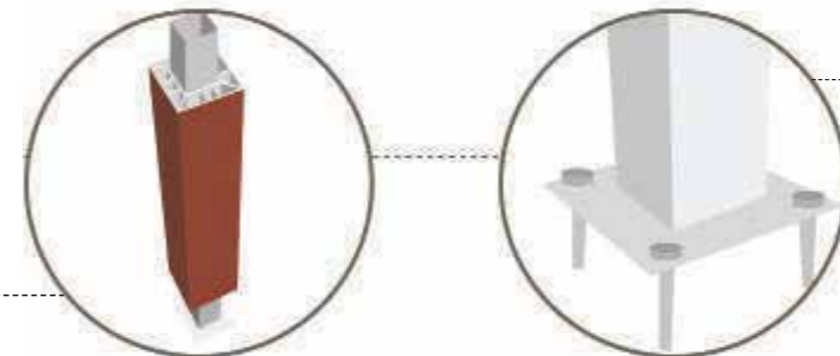

Column/Posts

Lay out the post positions and secure the posts on to the concrete pad with steel post-base anchors. Use a base plate cap if required.

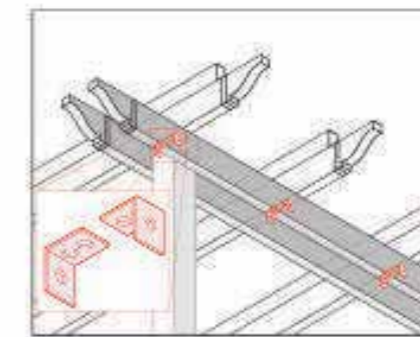
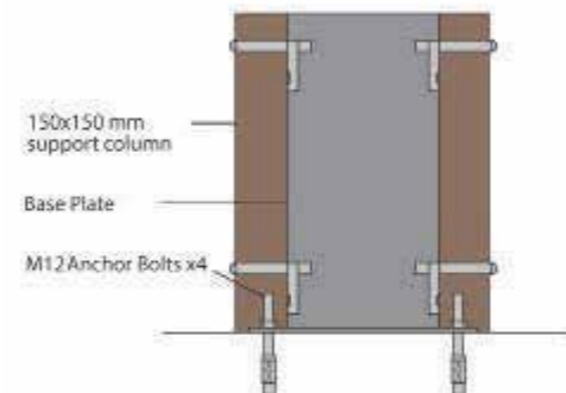

Optional

These clips, when mounted appropriately radically increase your pergola's uplift and sideways sway resistance under hefty wind loads.



MECHANISM

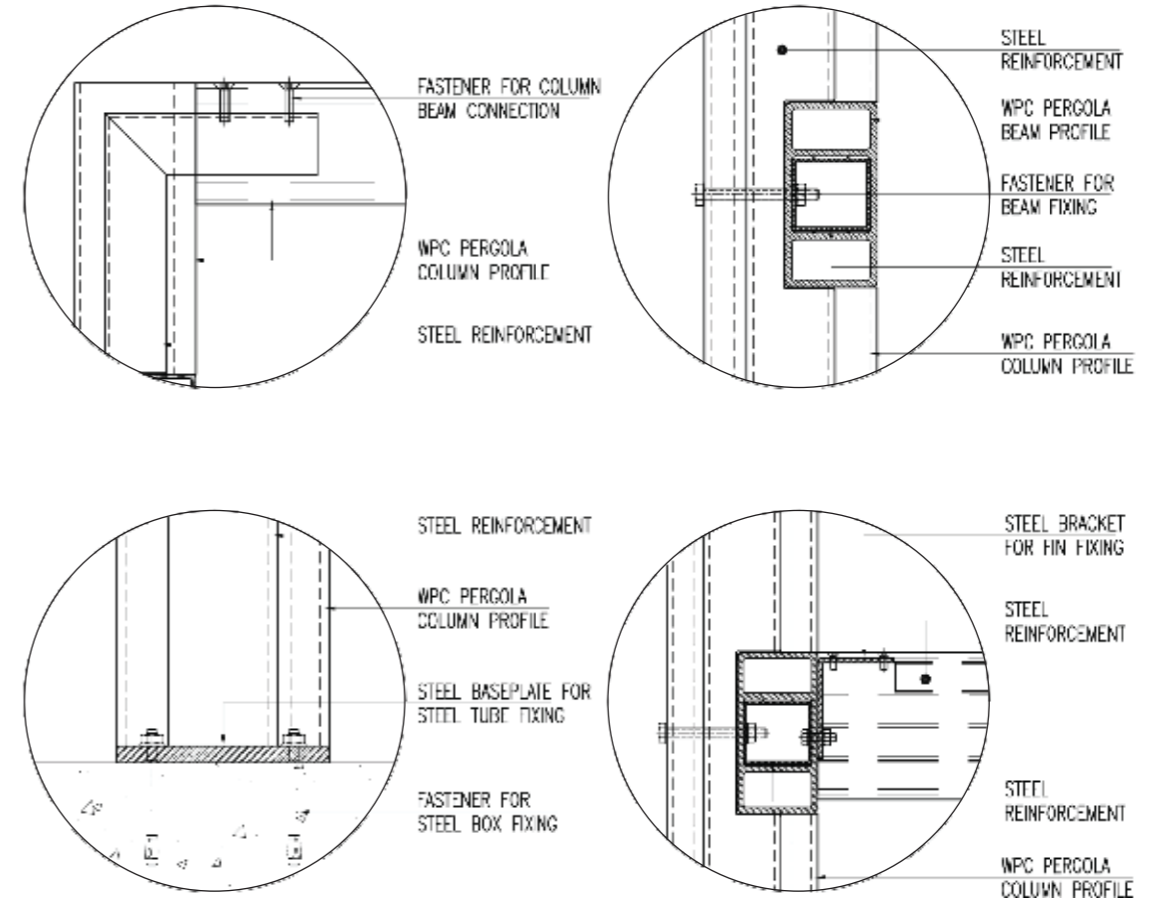

HARDWARES & ACCESSORIES



WPC COLUMN PROFILE



WPC BEAM PROFILE



WPC FIN PROFILE

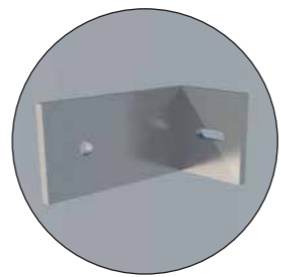

CONNECTING BRACKET



BOLT NUT

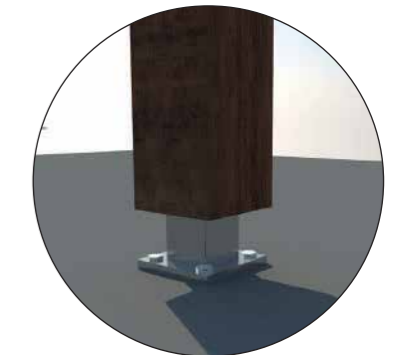
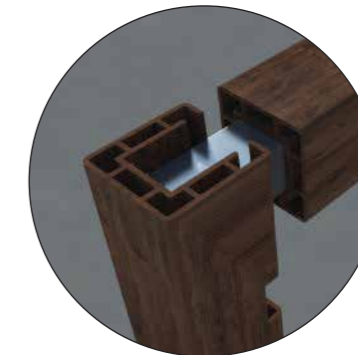

SHADES

FASCIA STRIPS



SN72W11 & SN146W11

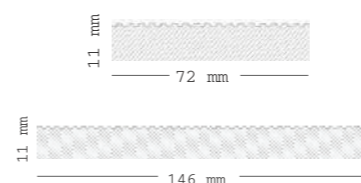

SN190W15



SN220W8



● Brown

● Chocolate

● Walnut

● Grey

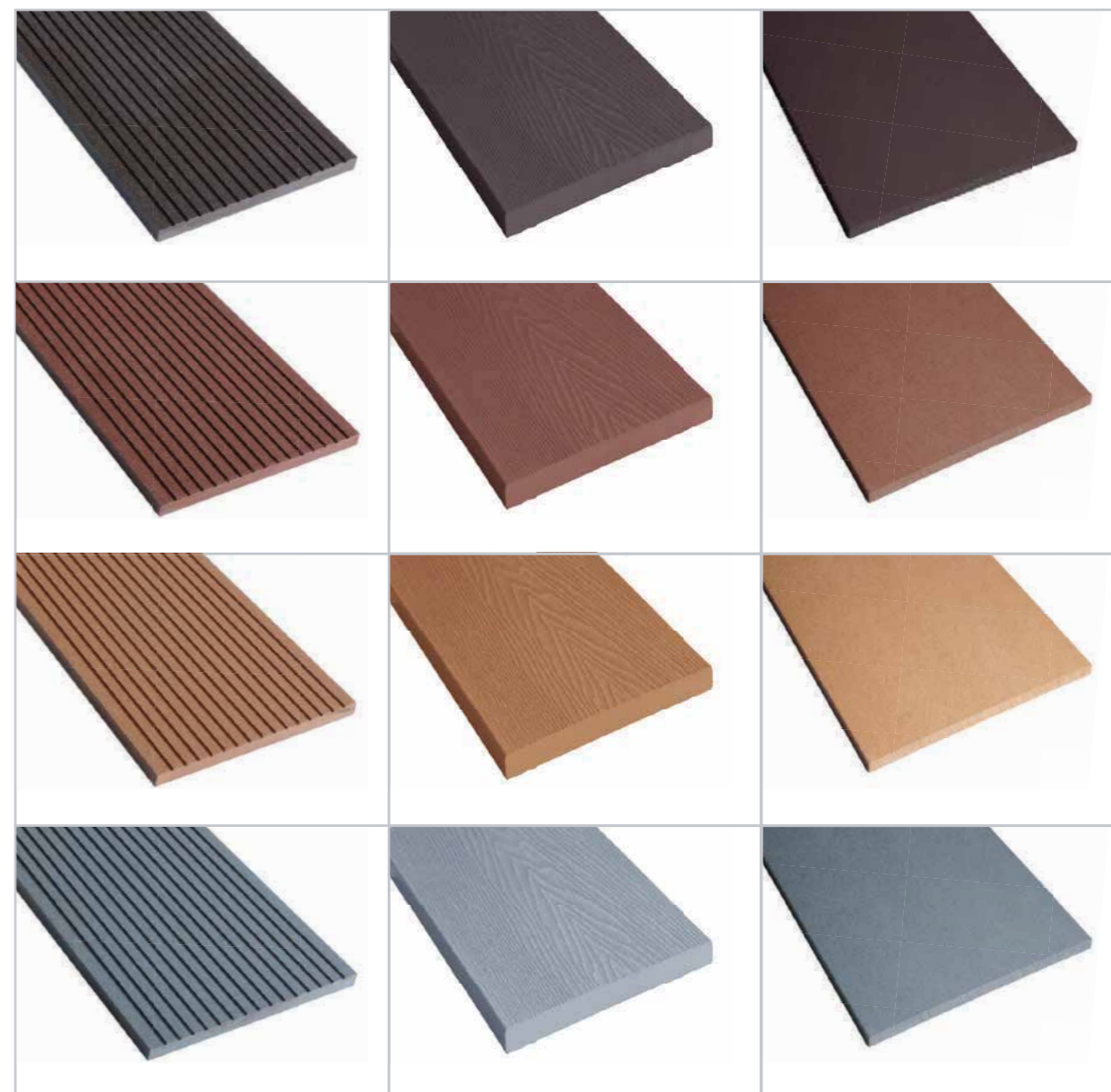

*Available in 2.9m length; subject to order upto 5.8m.



Balcony Casing



Balcony Railings/Drops



Plumbing Shaft Covering

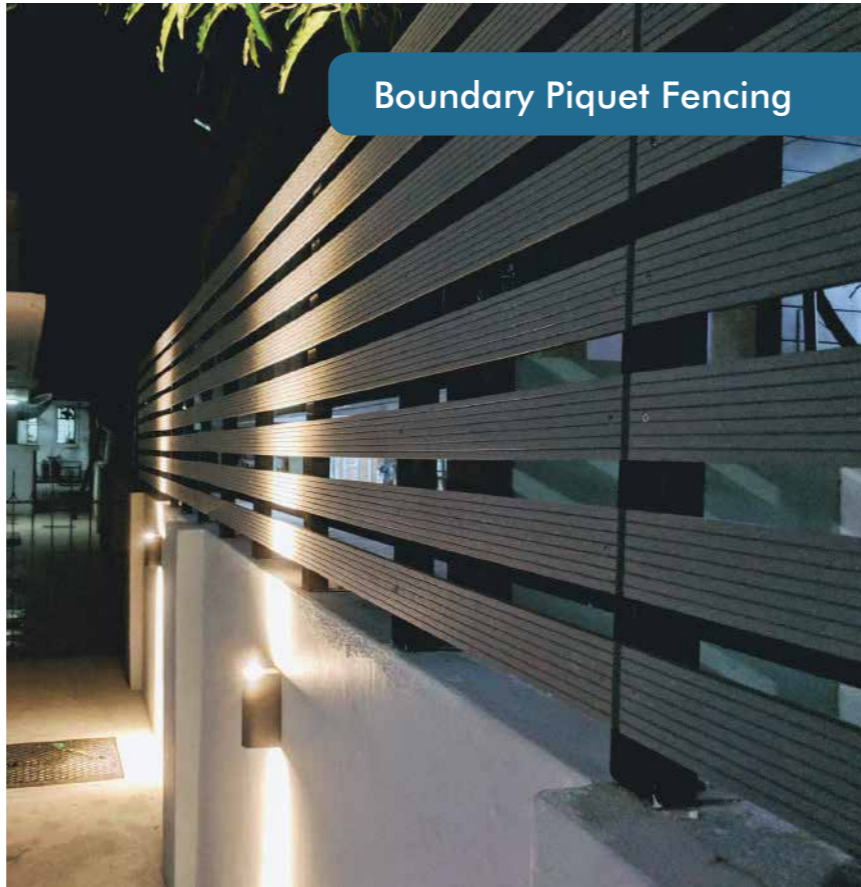

Boundary Piquet Fencing



Ventilated Partitions/Fencing



Gate Coverings

FIXING DETAIL | BALCONY DROPS

BALCONY CASING & RAILING

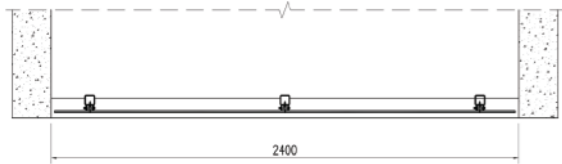

BALCONY SUNSHADING PLAN VIEW



SIDE VIEW

MECHANISM

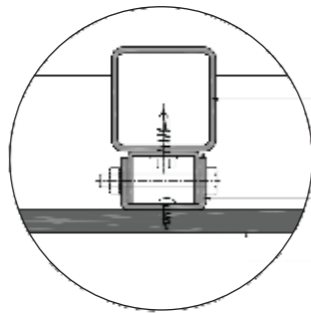

STEEL SUBSTRUCTURE
38X38X2MM THK
STEEL BRACKET FOR
CHANNEL FIXING
STEEL CHANNEL FOR
WPC SLATE FIXING
WPC FASCIA STRIPS

HORIZONTAL FIXING DETAIL

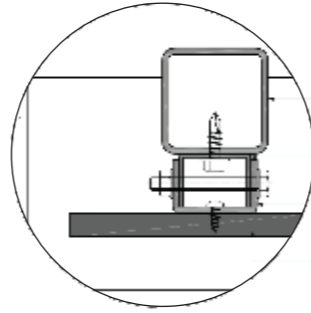

STEEL SUBSTRUCTURE
38X38X2MM THK
STEEL BRACKET FOR
CHANNEL FIXING
STEEL CHANNEL FOR
WPC SLATE FIXING
WPC FASCIA STRIPS

HORIZONTAL END FIXING DETAIL

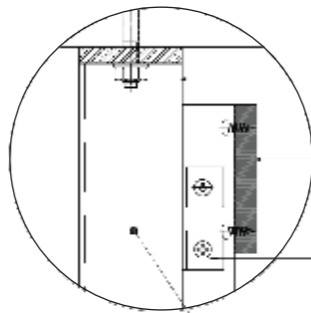

STEEL SUBSTRUCTURE
38X38X2MM THK
WPC FASCIA STRIPS
STEEL BRACKET FOR
CHANNEL FIXING
STEEL SUBSTRUCTURE
38X38X2MM THK

TOP FIXING DETAIL

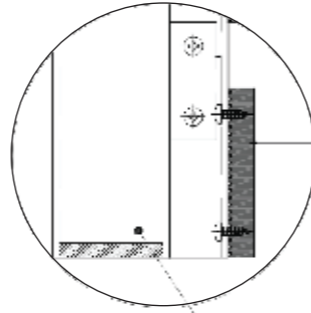

STEEL BRACKET FOR
CHANNEL FIXING
WPC FASCIA STRIPS
STEEL SUBSTRUCTURE
38X38X2MM THK

BOTTOM END FIXING DETAIL



SUBSTRUCTURE BOX



BOLT NUT



U CHANNEL/BRACKET



HEX SCREW #8X19

HARDWARE & ACCESSORIES

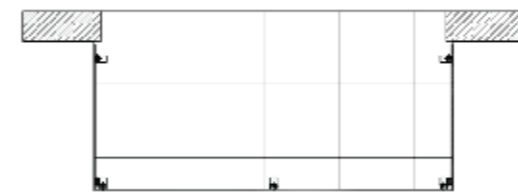

BALCONY CASING PLAN VIEW

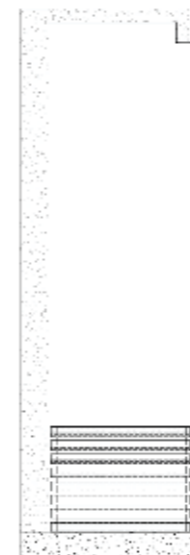

SIDE VIEW

MECHANISM

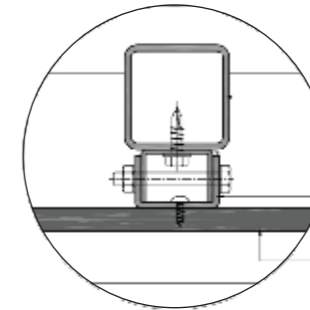

STEEL SUBSTRUCTURE
38X38X2MM THK
STEEL BRACKET FOR
CHANNEL FIXING
STEEL CHANNEL FOR
WPC SLATE FIXING
WPC FASCIA STRIPS

HORIZONTAL FIXING DETAIL

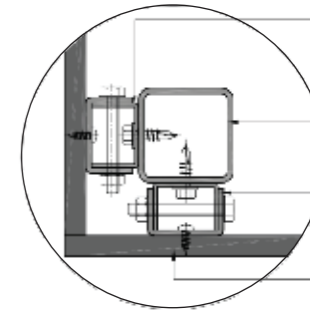

BRACKET FOR
CHANNEL FIXING
STEEL SUBSTRUCTURE
38X38X2MM THK
STEEL CHANNEL FOR
WPC SLATE FIXING
WPC FASCIA STRIPS
WPC SLATE OF REQUIRED
SIZE & SHADE

HORIZONTAL CORNER DETAIL



U CHANNEL FOR WPC
SLATE FIXING
WPC FASCIA STRIPS
STEEL BRACKET FOR
CHANNEL FIXING
STEEL SUBSTRUCTURE
38X38X2MM THK

BOTTOM FIXING DETAIL

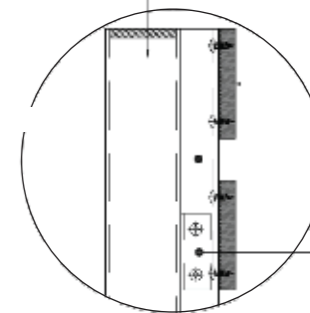

STEEL SUBSTRUCTURE
38X38X2MM THK
WPC FASCIA STRIPS
WPC SLATE OF REQUIRED
SIZE & SHADE
U CHANNEL FOR WPC
SLATE FIXING
STEEL BRACKET FOR
CHANNEL FIXING

TOP FIXING DETAIL

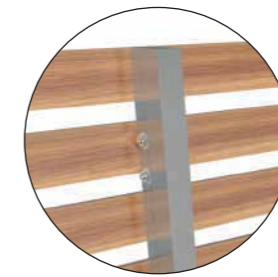

SUBSTRUCTURE BOX

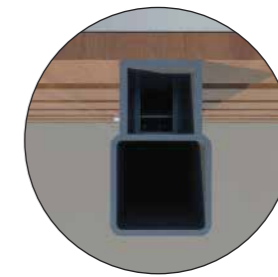

BOLT NUT

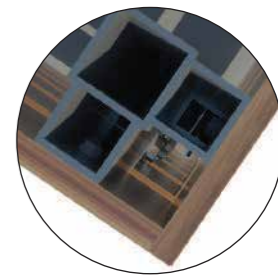

U CHANNEL/BRACKET



HEX SCREW #8X19

HARDWARE & ACCESSORIES

FIXING DETAIL | PLUMBING DUCT COVERING - EXPOSED

PLUMBING DUCT COVERING - CONCEALED



MECHANISM

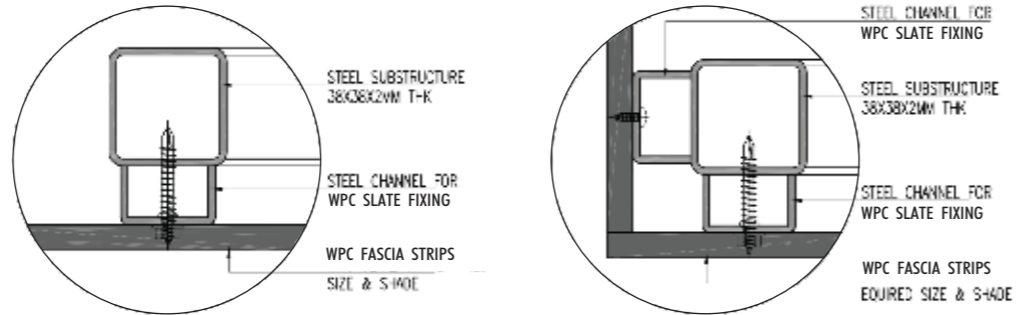

HORIZONTAL FIXING DETAIL

HORIZONTAL CORNER DETAIL

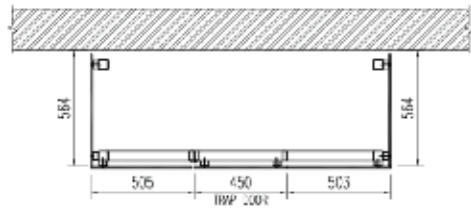

PLUMBING SHAFT CLADDING PLAN VIEW

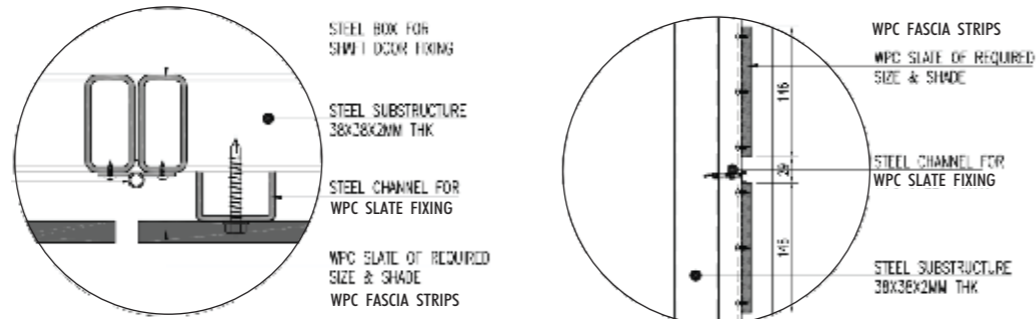

TRAP DOOR DETAIL

TYPICAL VERTICAL DETAIL



HARDWARE & ACCESSORIES



SUBSTRUCTURE BOX

HEX SCREW #10X38

U CHANNEL

HEX SCREW #8X19

SIDE VIEW

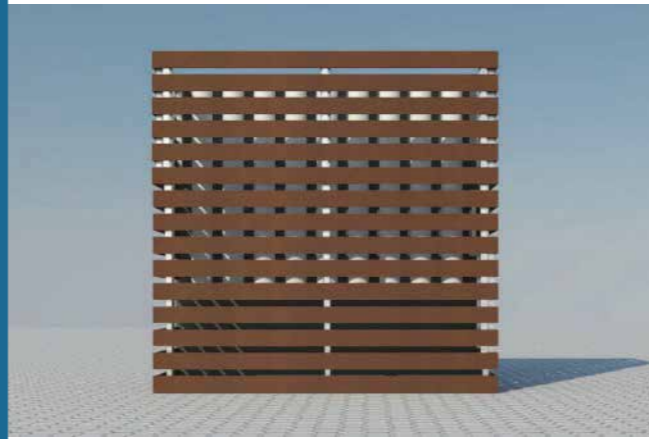

MECHANISM

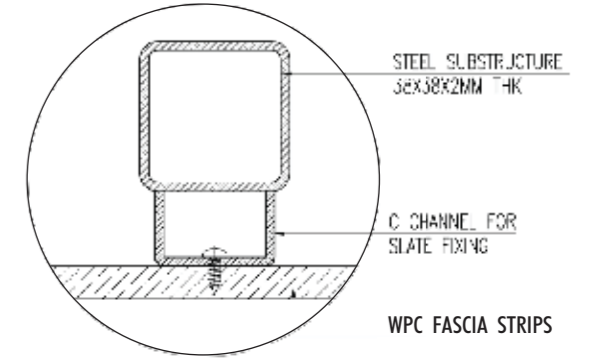

HORIZONTAL FIXING DETAIL

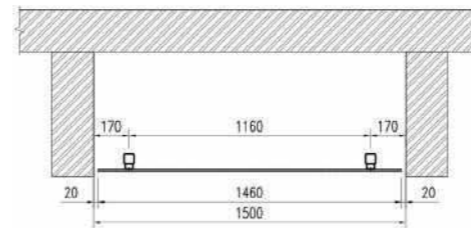

PLUMBING SHAFT CLADDING PLAN VIEW

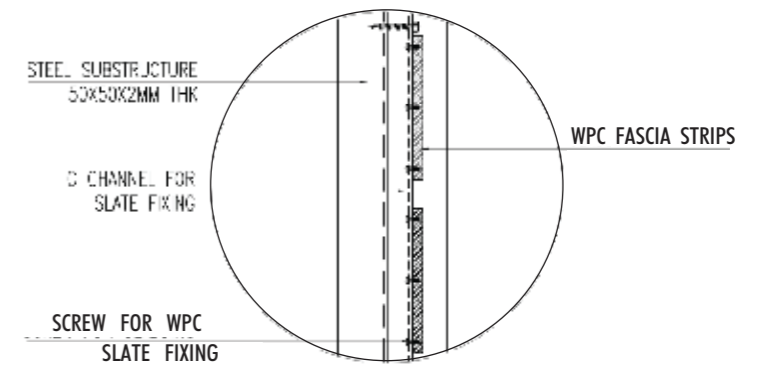

VERTICAL FIXING DETAIL



SIDE VIEW

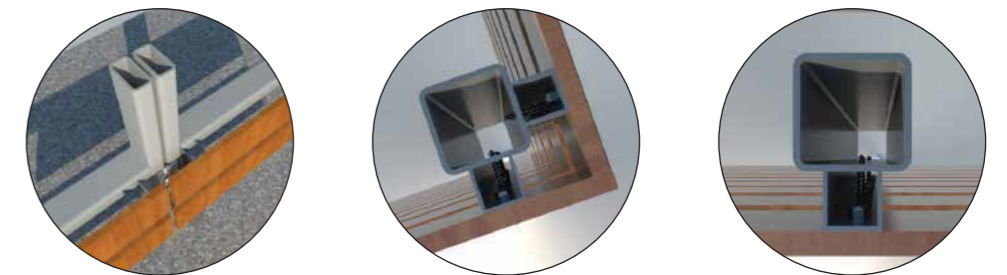

HARDWARE & ACCESSORIES



SUBSTRUCTURE BOX

HEX SCREW #10X38

U CHANNEL

HEX SCREW #8X19

MIXED USE APPLICATIONS

“THERE ARE 360 DEGREES, SO WHY STICK TO ONE?”

- ZAHA HADID

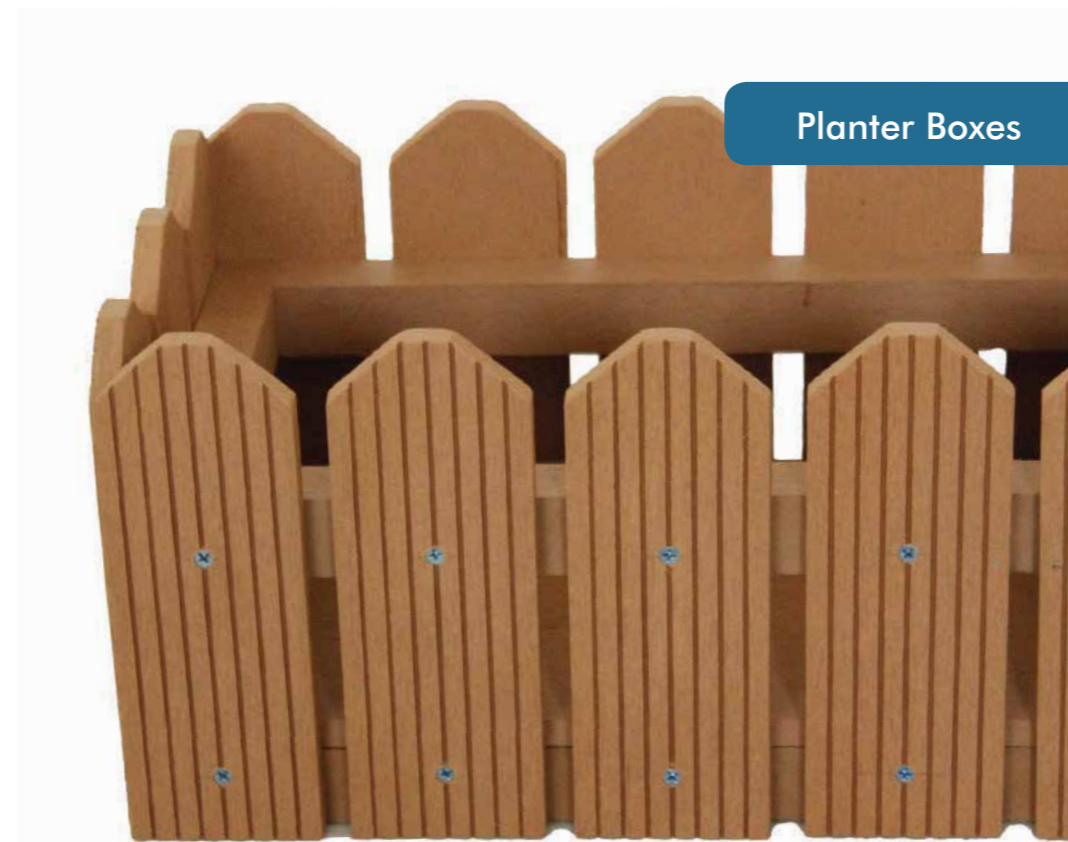

Planter Boxes

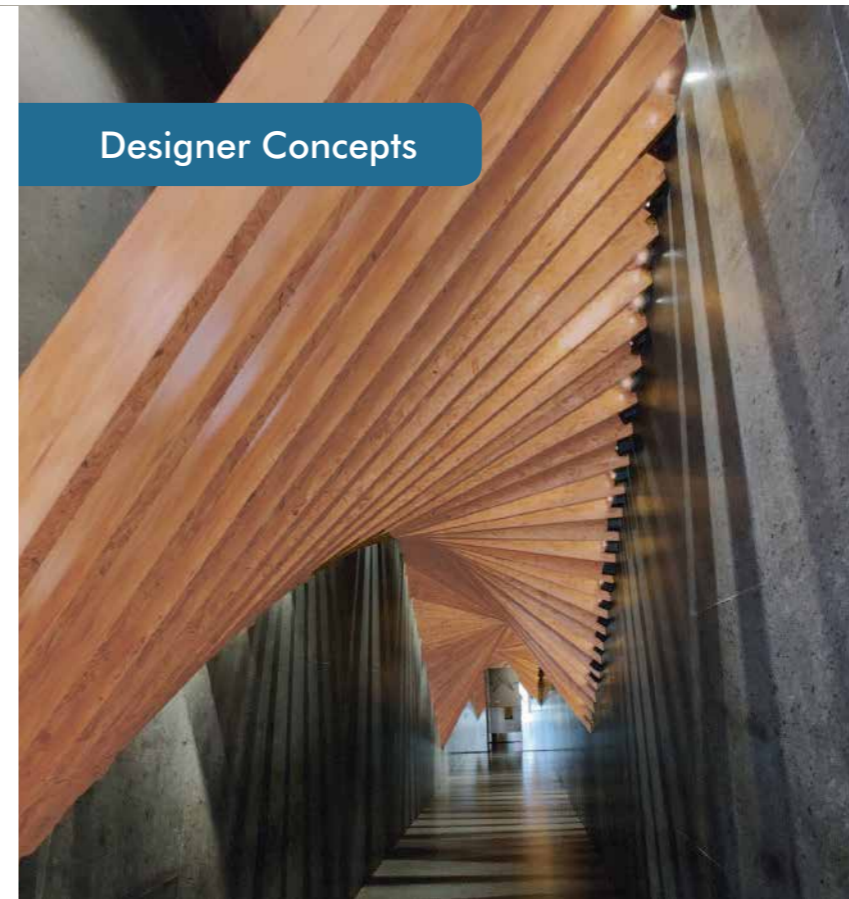

Designer Concepts



Bridge Walkway System

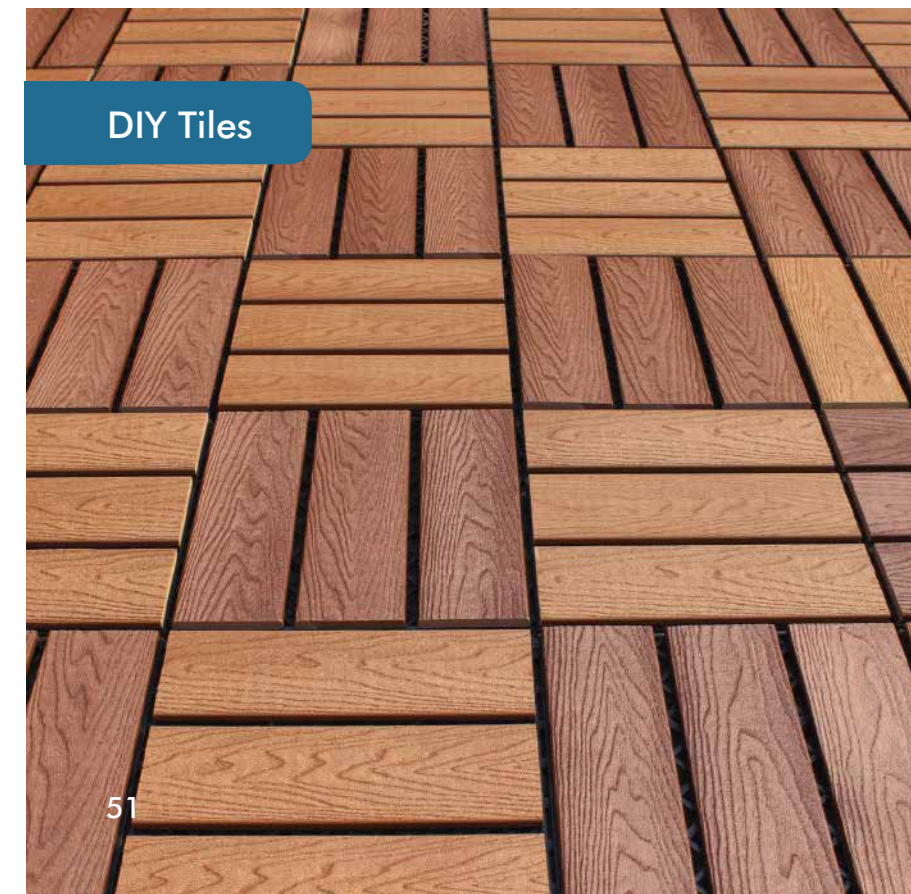

DIY Tiles



Customized Outdoor Furniture



Modern Architecture

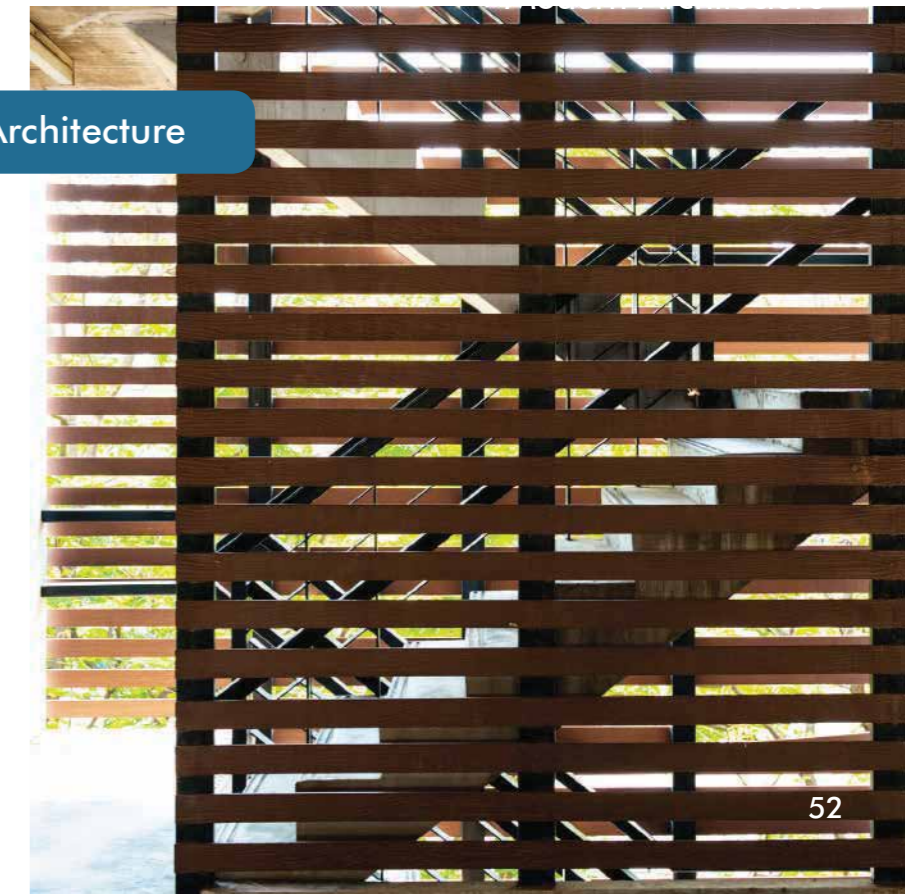

PROJECTS

»
Design , Transform, Enjoy
«

- M.H

Sodic pergola

Amwag Pergola



Marrassi pergola North coast



Negrisco Hotel Pergola

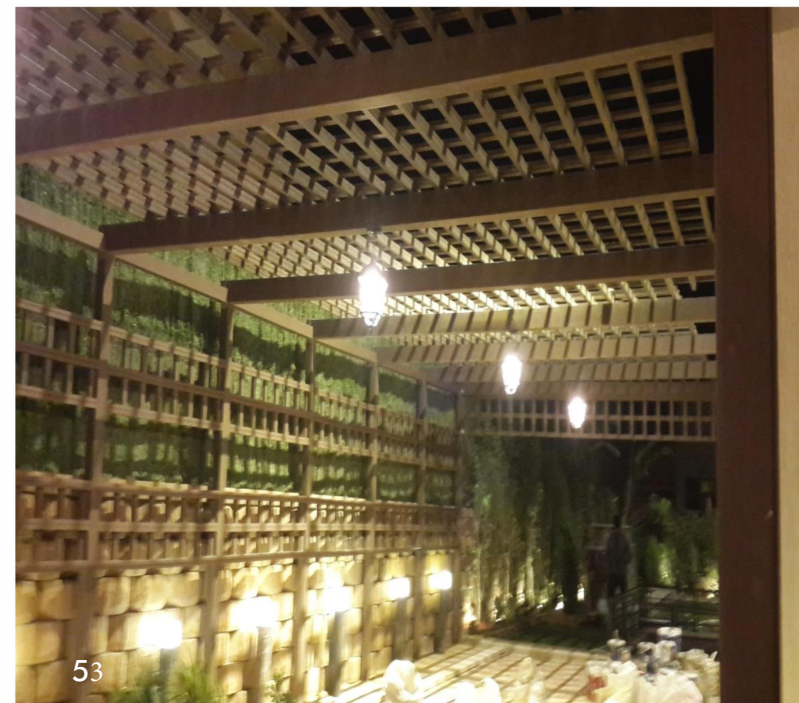

Wadi El Nile Pergola



Jordan pergola

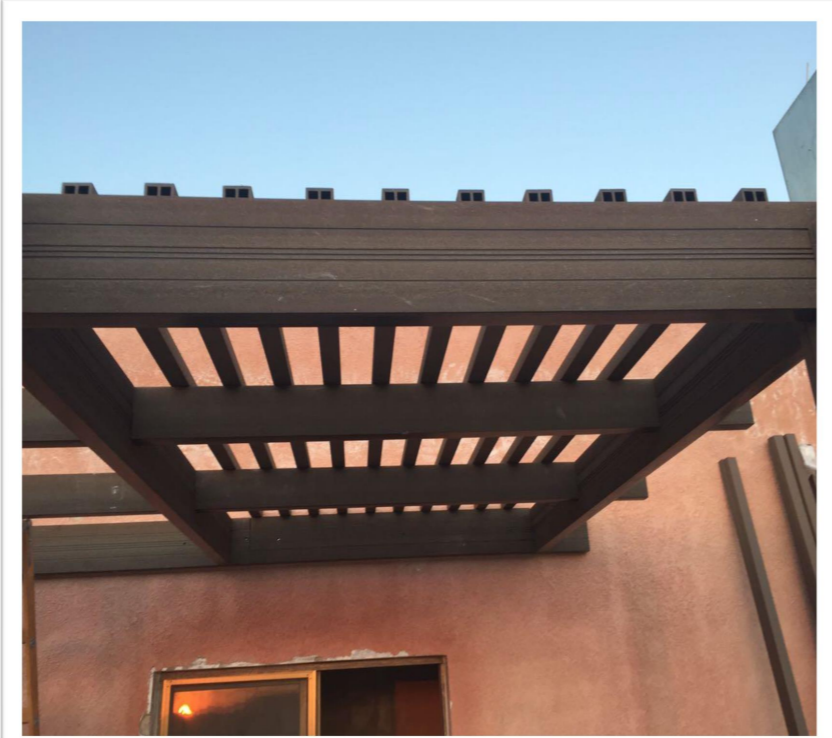

El Salab Fence



Jordan fences

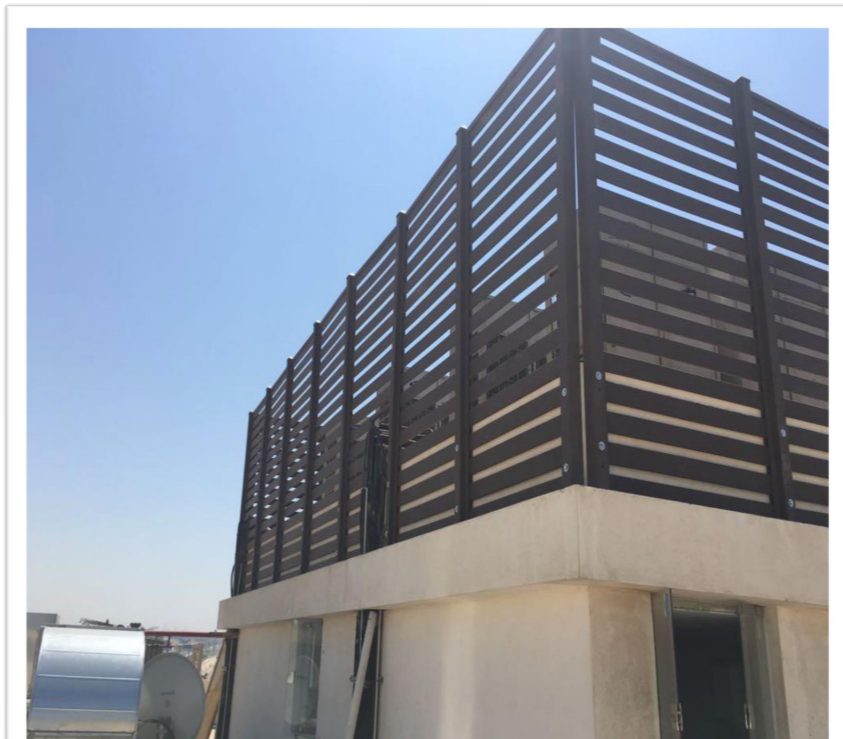

GOLD'S GYM



VILLA FAYROUS FENCE



Germany Fences



Sodic Swimming pool



Amr Helmy Show Room

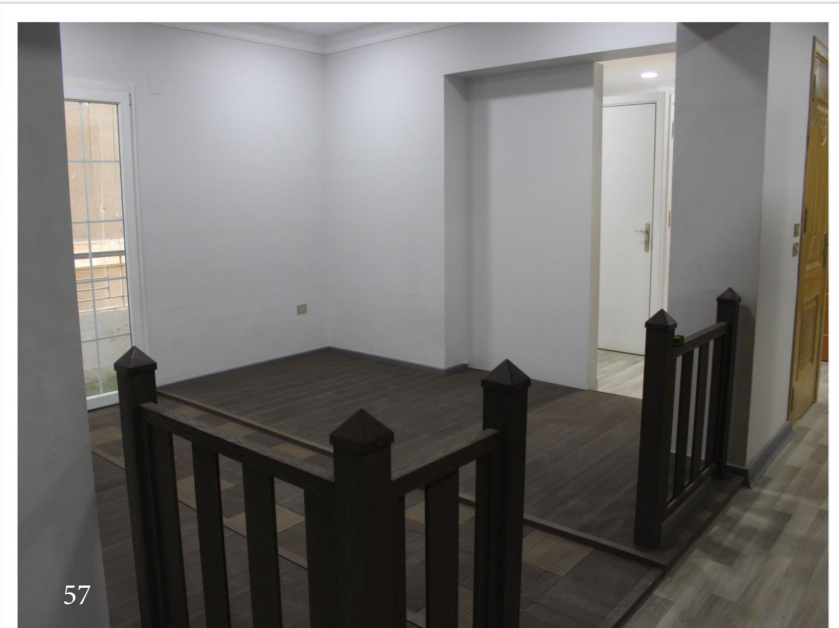

VILLA FAYROUS



Swimming pool Decking



El yassmen resort at Saudi Arabia



Elissa ship decking floor

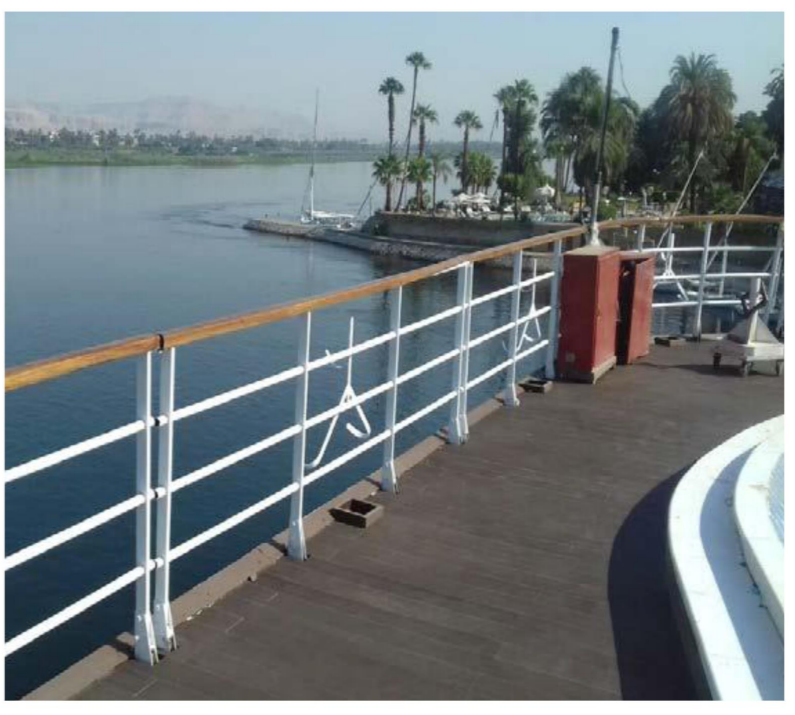

MARESELIA ELZA3FRANA

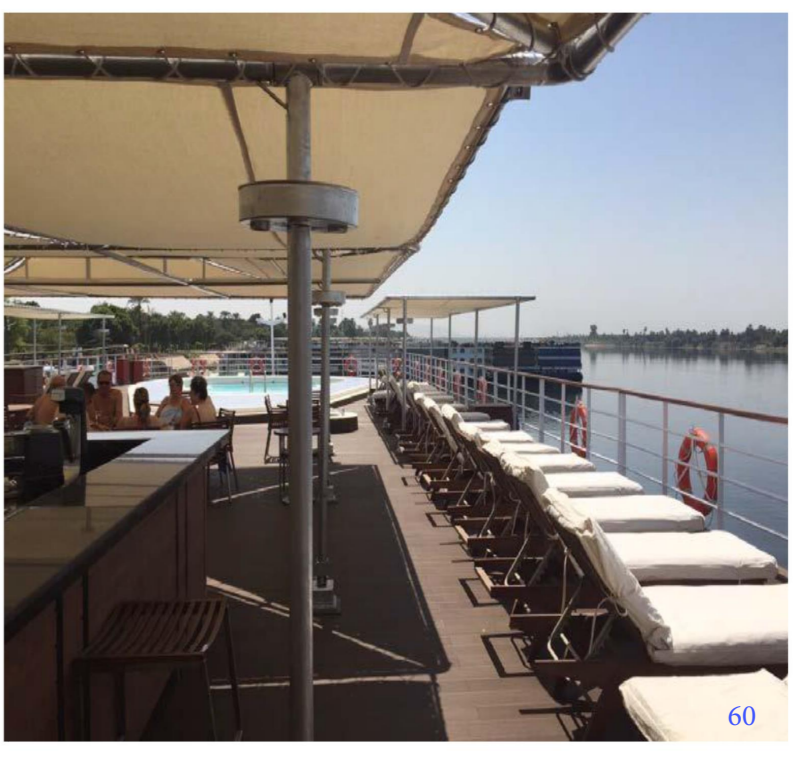
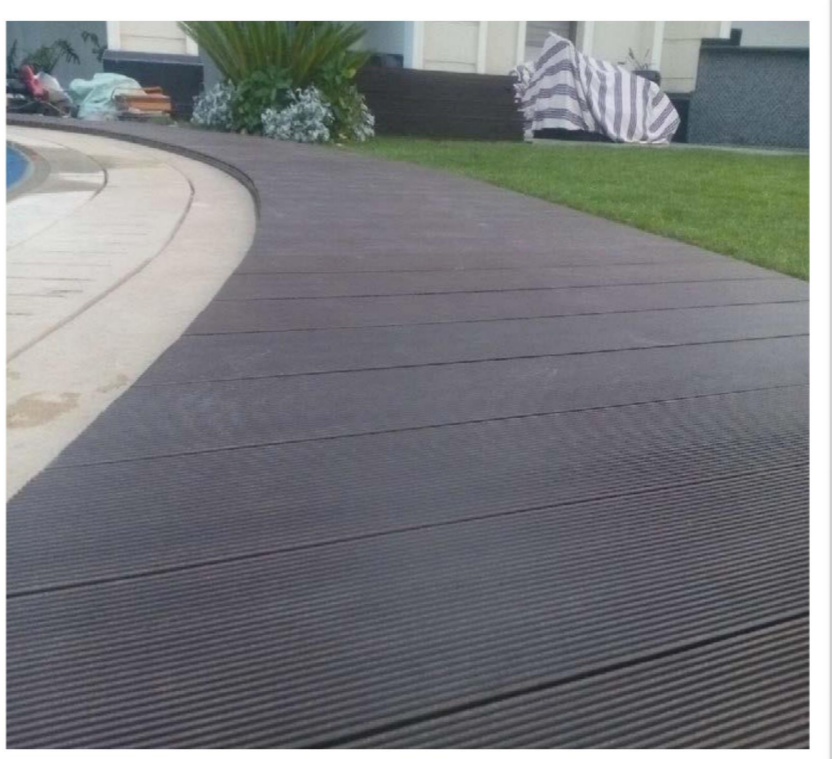

Elissa ship Stairs & Cladding

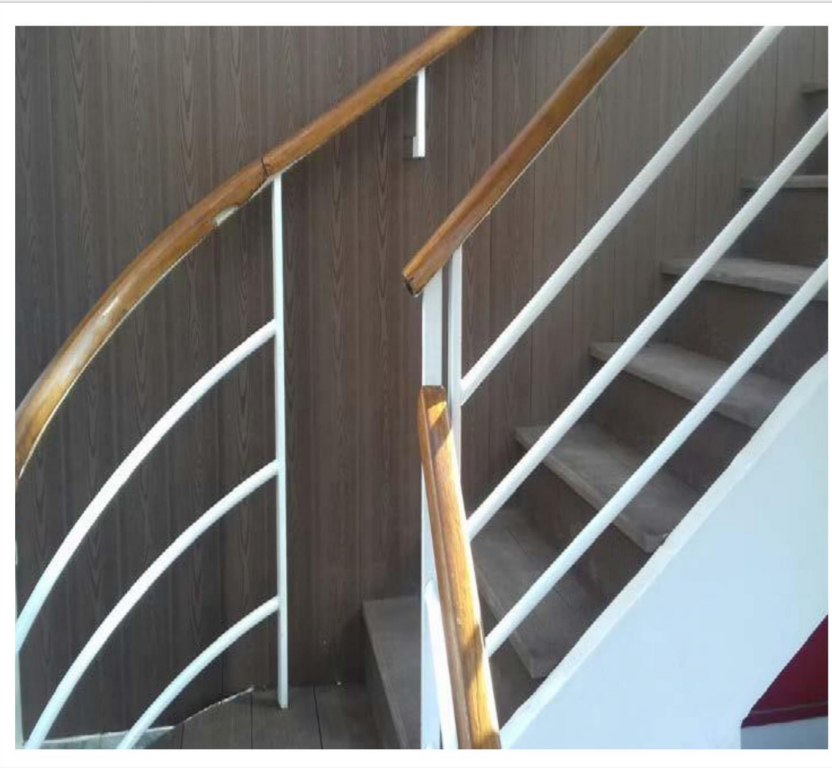

Nile Country Cladding House



OTHER



MARESELIA ELZA3FRANA



OTHER

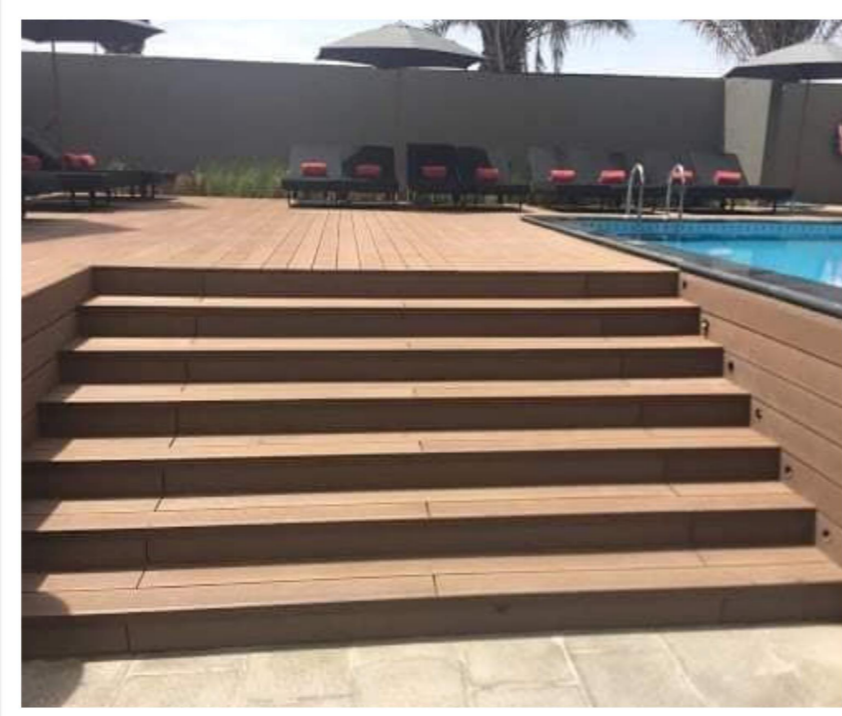

OTHER

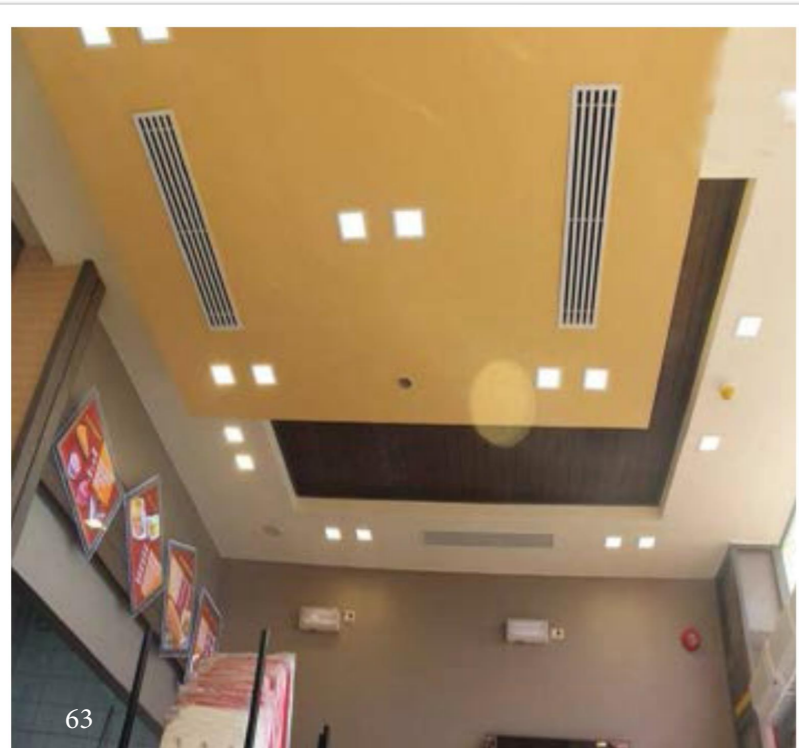
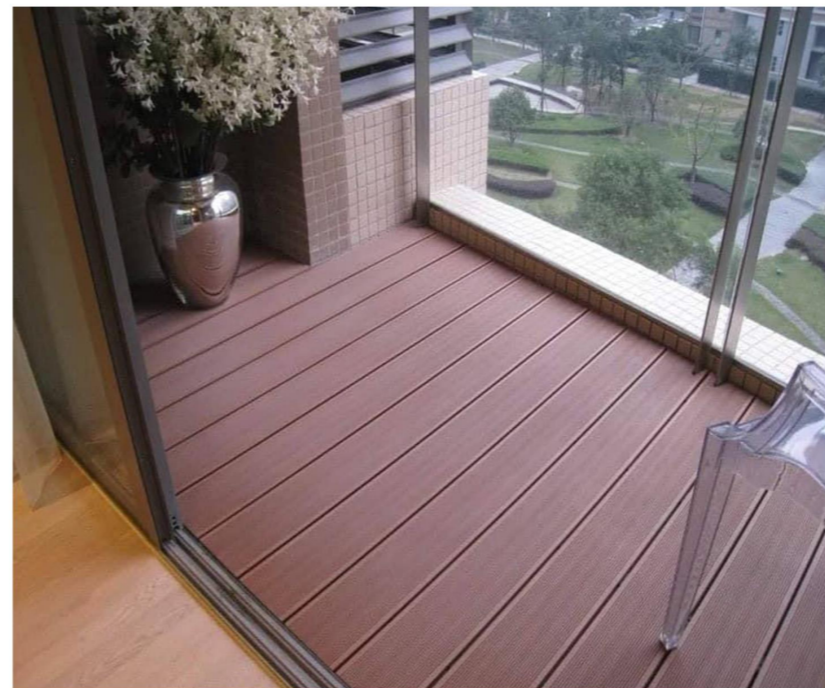

OTHER

FRENCH SCHOOL

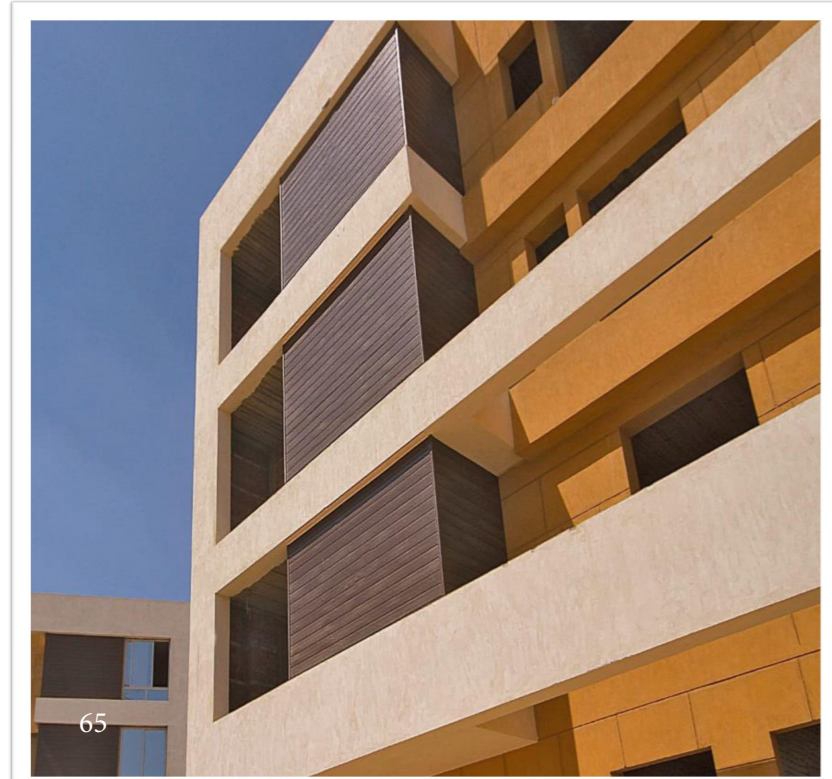

FUTURE CITY



SOLAYA CLUB



OPPO Reno5
2022/02/10 13:57

SOLAYA CLUB



OPPO Reno5
2022/02/10 13:58



OPPO Reno5
2022/02/03 14:52



OPPO Reno5
2022/02/10 13:58

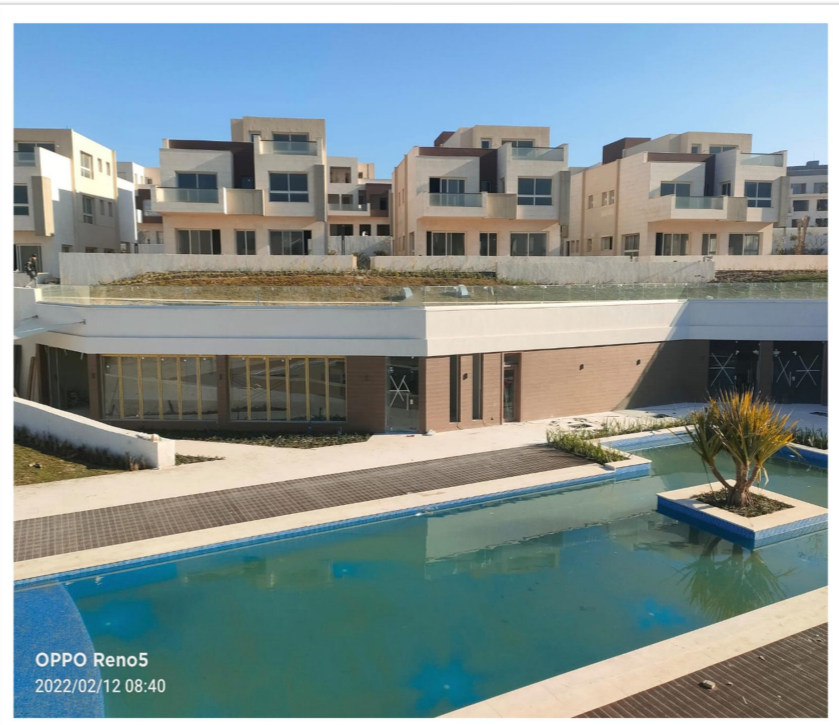

OPPO Reno5
2022/02/12 08:40



OPPO Reno5
2022/02/10 14:03

Equestrian CLUB

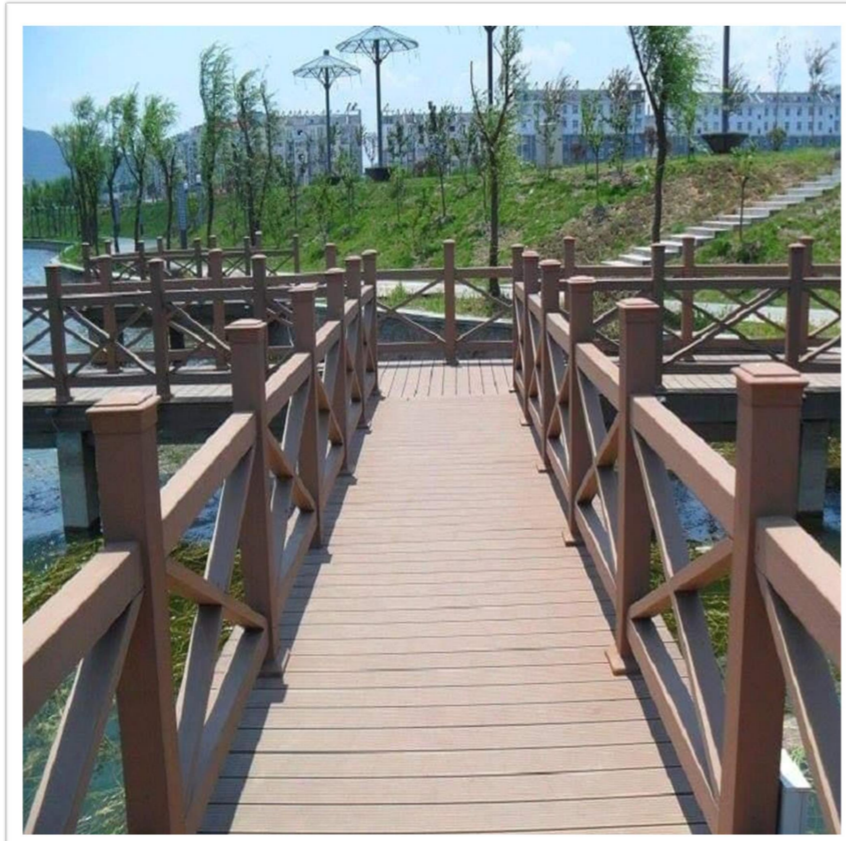
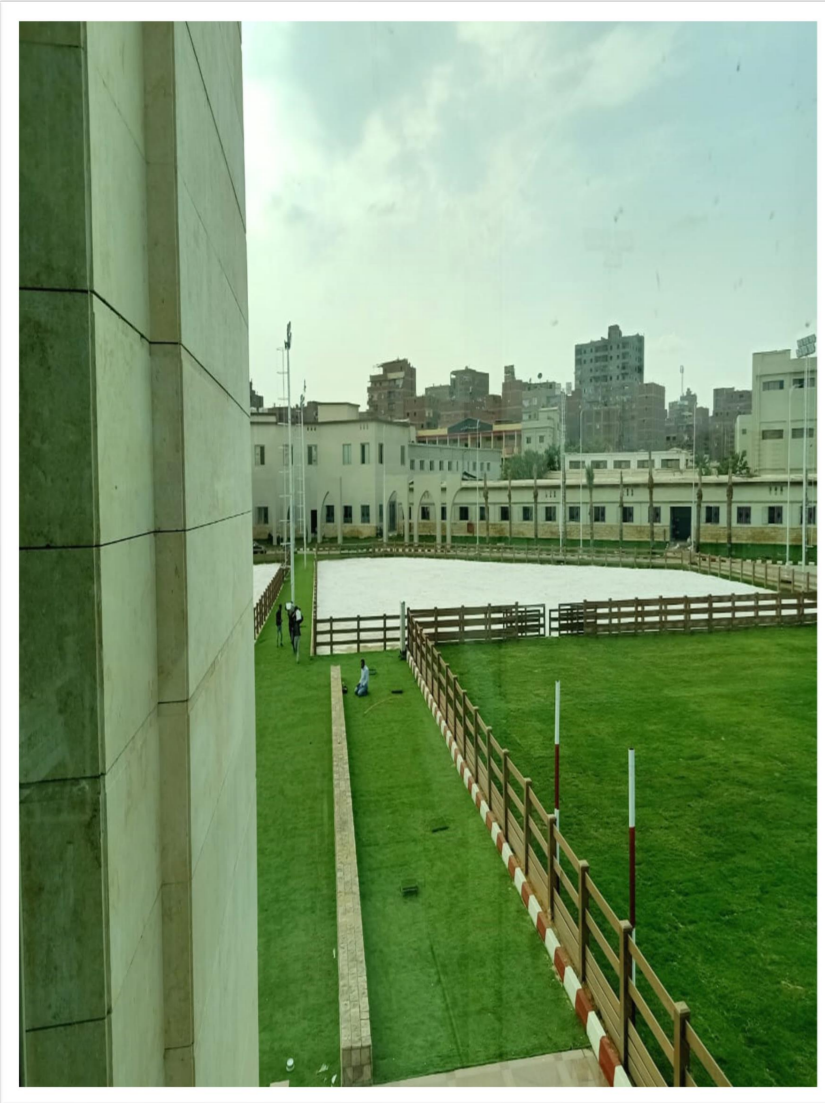

OTHER











OTHER



REST CHAIR-SEAT



 **6TH OF OCTOBER**
 **TEL :(+202) 38381279**
 **(+202) 383 1289**
 **FAX : (+ 202) 3835644**
 **SALES : 01222831116**
 **EMAIL : info@wpc-ecowood.com**
 **Facebook Page: wpc eco wood**
 **www.wpc-ecowood.com**

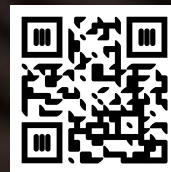

 **ECO
WOOD
WPC**